

# N40 Demand Management Study

---

Final Report

June 2017

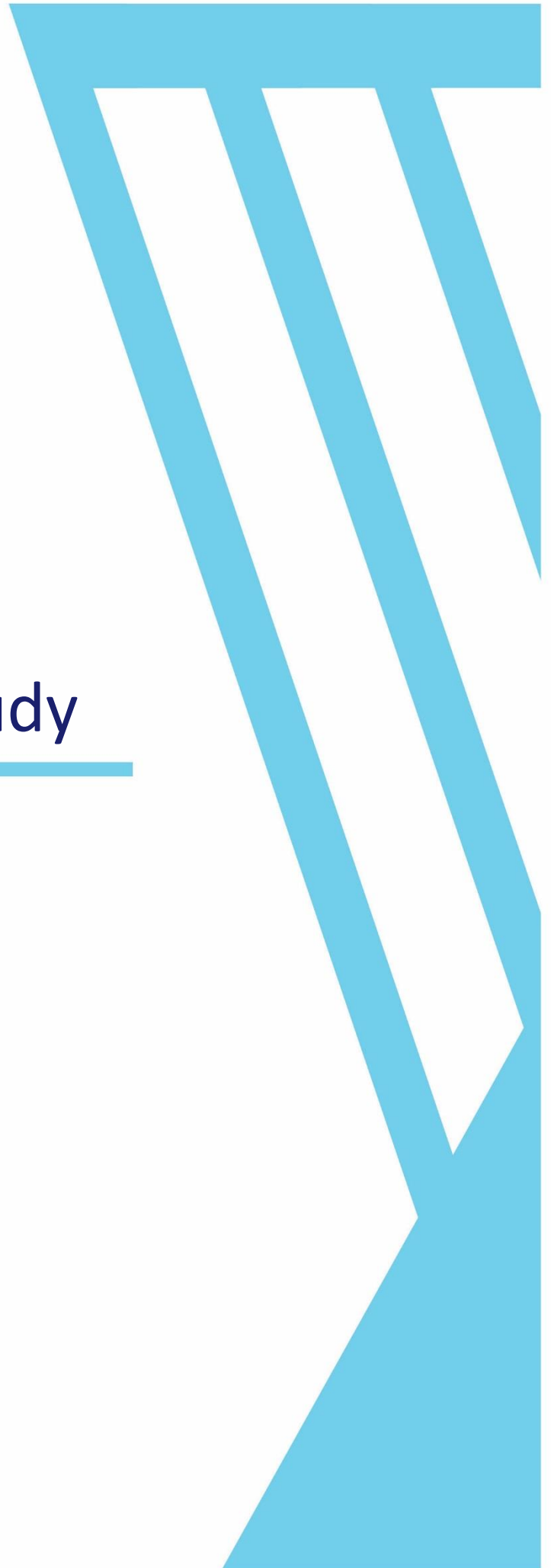

[BLANK]

# N40 Demand Management Study

## Final Report

May 2017



[BLANK]

## Table of Contents

Executive Summary .....	1
1.0 Introduction .....	4
1.1 Background .....	4
1.2 Evolution of the N40 Corridor .....	5
1.3 Current Study Context .....	6
1.4 Study Objective .....	7
2.0 Policy Context .....	9
2.1 Trans-European Transport Networks (TEN-T) .....	9
2.2 Smarter Travel, A Sustainable Transport Future 2009 - 2020 .....	11
2.3 Strategic Investment Framework for Land Transport .....	11
2.4 National Ports Policy 2013 .....	12
2.5 Spatial Planning and National Roads, Guidelines for Planning Authorities (2012) .....	12
2.6 Cork City Development Plan 2015 - 2021 .....	13
2.7 Cork County Development Plan 2014 .....	13
3.0 Need for Demand Management .....	14
3.1 Overview .....	14
3.2 Population & Employment .....	14
3.3 Existing Traffic Flows, Patterns & Behaviour .....	16
3.4 N40 Network Operational Issues .....	30
3.5 Assessment of Future Growth .....	31
3.6 External Impact of N40 Conditions .....	32
3.7 Conclusions .....	35
4.0 Assessment of Demand Management .....	36
4.1 The Problem .....	36
4.2 Stakeholder Consultation .....	37
4.3 Specific Objectives of the Demand Management Measures .....	38
5.0 Potential Demand Management Solutions .....	39
5.1 Definition and Analysis of Alternatives .....	39
5.2 Analysis Tools .....	43
5.3 Smarter Travel .....	45
5.4 Intelligent Transport Systems/Traffic Control .....	46
5.5 Capacity Enhancement .....	48

5.6 Priority Measures .....	51
5.7 Information Measures.....	51
5.8 Network Control .....	52
5.9 Fiscal Measures .....	52
6.0 Summary of Indicative N40 Demand Management Scheme .....	60
6.1 Identification of Indicative Scheme .....	60
6.2 Key Stakeholders .....	61
6.3 Benefits and Impacts of the Measures.....	61
6.4 Implementation and Phasing .....	70
6.5 Risk Analysis.....	72
7.0 Conclusions.....	75

---

## Executive Summary

The N40 Cork South Ring Road is one of the most heavily trafficked roads in the country, after the M50 and forms part of the Trans-European Transport Network (TEN-T).

The N40 corridor was constructed and upgraded incrementally since the early 1990s between Junction 1 (Poulavone) and Junction 11 (Dunkettle) over a number of decades at significant investment. In more recent years, infrastructural work along the N40 has tended to focus on maximising the efficiency and throughput of the corridor with a number of interchange grade separation schemes completed

The Dunkettle Interchange (Junction 11) represents the last at-grade junction on the N40. An upgrade of Junction 11 (Dunkettle), which includes a free-flow arrangement was granted approval with conditions by An Bord Pleanála in 2013. One of the conditions imposed by An Bord Pleanála required various actions to be undertaken by TII to monitor traffic on the N40 due to apparent concerns by the Bord surrounding “*the capacity constraints of the Jack Lynch Tunnel*”. In light of this, it was recognised that future traffic demand on the N40 would need to be managed if the N40 and the Jack Lynch Tunnel were not to act as a constraint on development within the Cork Metropolitan Area.

In order to progress with this matter, the National Roads Authority (now Transport Infrastructure Ireland (TII)), in consultation with Cork City Council, Cork County Council and various other stakeholders, undertook a study to identify a scheme of indicative Demand Management Measures for the N40.

The potential provision of demand management measures along the N40 corridor is in keeping with a number of European, national, regional and local planning policy documents, including:

- Trans European Transport Networks (TEN-T) Regulations (Regulation (EU) No 1315/2013)
- Smarter Travel, A Sustainable Transport Future 2009 – 2020
- Strategic Investment Framework for Land Transport
- National Ports Policy 2013
- Spatial Planning and National Roads, Guidelines for Planning Authorities (2012)
- Cork City Development Plan 2015 – 2021
- Cork County Development Plan 2014

A detailed assessment of existing conditions has found that the N40 frequently experiences traffic congestion and travel time unreliability due to a combination of high mainline flows and frequent, congested junctions.

On the basis of the detailed assessment, the requirements of demand management measures are as follows:

- Address the strong levels of growth in transport demand, predominantly through managing growth in the level of discretionary traffic, such that the strategic function of the N40 can be protected;
- Manage and mitigate the safety and reliability impacts that result from congested conditions, and which also threaten the strategic function of the N40

In essence, these requirements relate to the need to influence demand that may be attracted to the N40, and subsequently manage the traffic that nevertheless has chosen to use the N40. This requires two very different forms of management, one based on influencing the generation of demand and the other based on controlling traffic flow which materialises, a distinction that was recognised throughout the study.

An extensive range of potential demand management measures was initially considered and this was sifted to identify those measures which could be considered further. These measures are shown in Table 0.1 below:

Category	Measures Taken Forward
<b>Smarter Travel</b>	<ul style="list-style-type: none"> <li>• Travel Planning &amp; Awareness</li> <li>• Planning Policies</li> <li>• Integrated Land Use and Transport</li> </ul>
<b>ITS / Control</b>	<ul style="list-style-type: none"> <li>• Upgrade to Motorway</li> <li>• Access Control</li> <li>• Incident Detection</li> <li>• Variable Speed Limits</li> </ul>
<b>Capacity</b>	<ul style="list-style-type: none"> <li>• Interchange Capacities</li> <li>• Junction Capacities</li> <li>• Alternative Complementary Routes</li> </ul>
<b>Priority</b>	None
<b>Information</b>	<ul style="list-style-type: none"> <li>• Internet</li> <li>• Roadside Information</li> </ul>
<b>Control</b>	<ul style="list-style-type: none"> <li>• National Control Centre</li> <li>• Network Patrols</li> </ul>
<b>Fiscal</b>	<ul style="list-style-type: none"> <li>• Distance Based Tolling</li> <li>• Toll by Time</li> <li>• Toll by Vehicle Type</li> </ul>

**Table 0.1 - Summary of Measures to be Considered Further**

A detailed analysis of the above measures was undertaken using a detailed traffic model developed specifically for the scheme and using High Growth traffic forecasts from the TII Project Appraisal Guidelines as the most appropriate and closest match to the population and employment forecasts in the Cork Area Strategic Plan.

Following this analysis, the indicative N40 Demand Management Scheme was identified as shown in Table 0.2, indicatively, in Figure 0.1 and discussed further in the following paragraphs.

The analysis highlighted the need for an integrated land use and transportation strategy for the Cork Metropolitan Area with a focus on reducing the significant car commuter demand on the N40 during peak times and addressing the use of the N40 as an access route to the various commercial and retail developments in close proximity to the route. This must be the primary, albeit indirect, demand management measure.

The analysis demonstrated that there are a number of traffic management and improvement interventions required to the N40 prior to any direct demand management intervention in order to address current capacity constraints, particularly at the junctions. The development of some alternative complimentary routes, as identified in relevant Cork County Council policies, will also benefit the N40 by providing alternative options for N40 traffic.

The assessment of the fiscal demand management measures has been based on an indicative three toll point open system, which provides a coverage rate of greater than 80% of trips. This has been derived to demonstrate the benefits and impacts of such a solution.



The analysis showed clearly that fiscal measures can have a significant impact on managing future demand on the N40, notwithstanding the complexity of the overall road network in the Cork Metropolitan Area and the limited alternatives to the Jack Lynch Tunnel.

N40 Intervention	Description of Specific Measures
<b>Integrated Land Use and Transportation</b>	<ul style="list-style-type: none"> <li>• Travel Planning &amp; Awareness</li> <li>• Land Use Policies</li> <li>• Public Transport</li> <li>• Parking Policy</li> </ul>
<b>Targeted Upgrades</b>	<ul style="list-style-type: none"> <li>• Upgrade to Motorway</li> <li>• Dunkettle Interchange Upgrade</li> <li>• Off Line Junction Improvements</li> <li>• Hard Shoulder Queuing</li> </ul>
<b>Smart Motorway Interventions</b>	<ul style="list-style-type: none"> <li>• Traffic Control Centre</li> <li>• Variable Speed Limits</li> <li>• Variable Messaging Signage</li> <li>• CCTV</li> <li>• Incident Detection</li> <li>• Network Patrols</li> </ul>
<b>Alternative Complimentary Routes</b>	<ul style="list-style-type: none"> <li>• Douglas East-West Link</li> <li>• Airport – Sarsfield Road Link</li> </ul>
<b>Fiscal</b>	<ul style="list-style-type: none"> <li>• Multi Point Tolling</li> </ul>

**Table 0.2 - Summary of the Indicative Scheme of Specific Demand Management Measures**

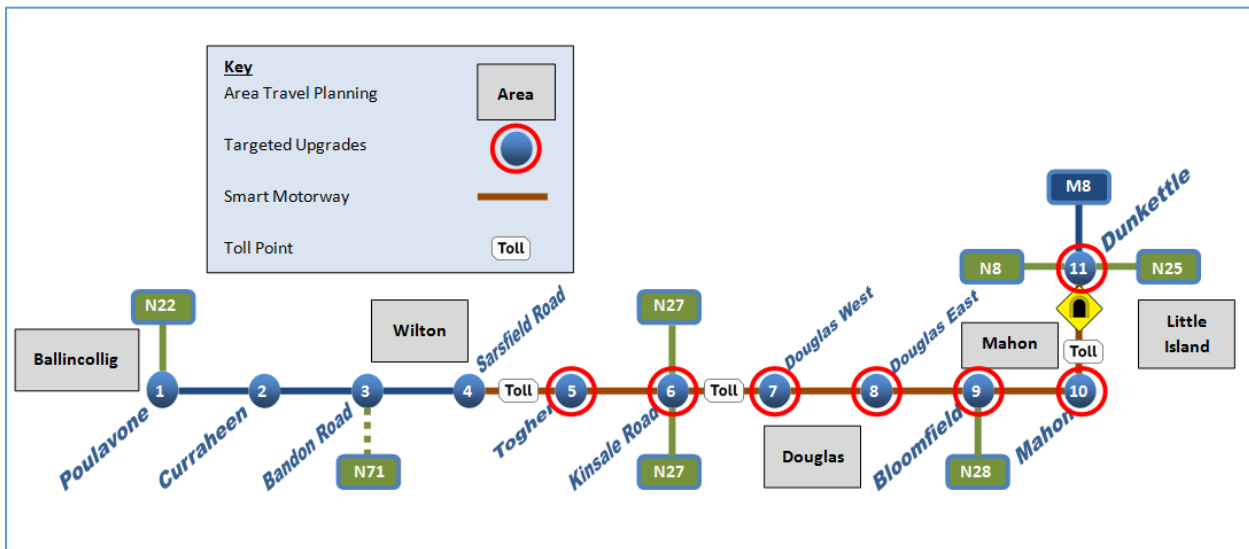

**Figure 0.1 – Proposed Indicative Scheme of Specific N40 Demand Management Measures**

In conclusion, the N40 Demand Management Study has demonstrated the need for demand management on the N40, provided a rigorous assessment of potential demand management interventions specifically for the N40 and the demonstrated the feasibility of the indicative demand management measures. The study will provide a basis for the development of a detailed scheme for implementation.

## 1.0 Introduction

### 1.1 Background

The N40 Cork South Ring Road is one of the most heavily trafficked roads in the country, after the M50 and forms part of the Trans-European Transport Network (TEN-T).

The N40 corridor was constructed and upgraded incrementally since the early 1990s between Junction 1 (Poulavone) and Junction 11 (Dunkettle) over a number of decades at significant investment. In more recent years, infrastructural work along the N40 has tended to focus on maximising the efficiency and throughput of the corridor with a number of interchange grade separation schemes completed.

Figure 1.1 provides an overview of the N40 corridor in its present form within the context of the wider road network within the Cork Metropolitan Area.



**Figure 1.1 – Overview of N40 Corridor**

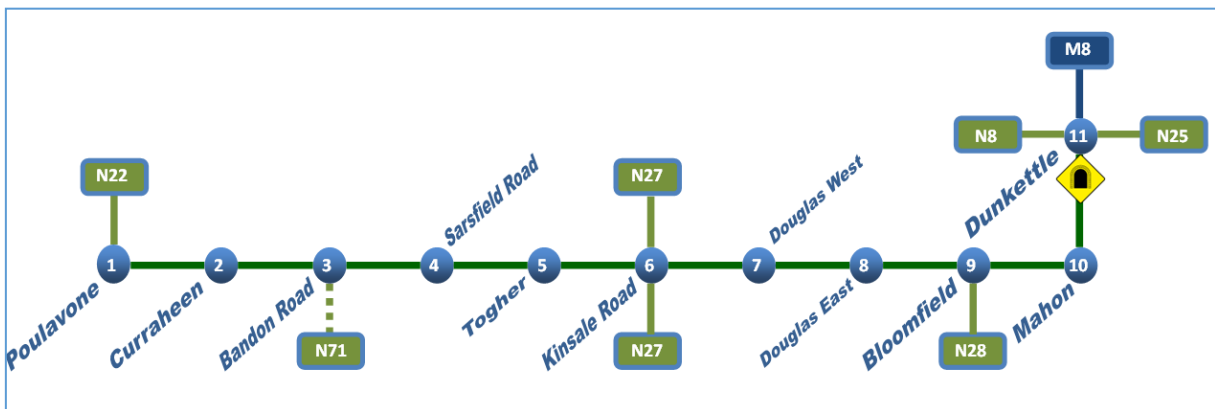

**Figure 1.2 – N40 Schematic with Junction Numbers and Names**

The N40 is a corridor of significant strategic value at both a national and regional level. The N40, via Junction 9 (Bloomfield) and the N28 provides access to the Port of Cork operations at Ringaskiddy. The N40 also provides access to Cork Airport via Junction 6 (Kinsale Road) and the N27. In addition to the above, there are numerous strategic employment zones located to the south of the N40 corridor. The N40 in turn provides access to the National Motorway network via Junction 11 (Dunkettle). As such, the N40 corridor provides an important

means of access to a variety of land uses to the south of Cork City, in addition to providing access to international markets for freight through Ringaskiddy and tourist and business traffic through Cork Airport.

Notwithstanding the strategic nature of the corridor, significant development has occurred over the past two decades in the Cork suburbs and towns served by the N40 corridor, most notably: Douglas; Maryborough; Rochestown; Little Island; Mahon; Carrigaline and Ballincollig. Development along the corridor has occurred to such an extent, that the N40 is now located within the suburbs of Cork; as opposed to an outer ring as initially envisioned. During this period, the complementary improvement to public transport has struggled to keep pace with development, notwithstanding the enhancements of rail services, and the introduction of new bus routes.

Certain sections of the N40 were observed carrying in excess of 80,000 vehicles per day in 2016.<sup>1</sup> Examining the N40 in the vicinity of the Jack Lynch Tunnel reveals a 4% growth in traffic volumes reported by the TII Traffic Monitoring Unit (TMU) at this location between 2014 and 2015 and 3% growth between 2015 and 2016. This underlines the steady and consistent growth in traffic on the N40 in the period 2014 - 2016 and it is expected that such growth will continue as the economy continues to grow.

## 1.2 Evolution of the N40 Corridor

The N40 corridor was constructed and upgraded incrementally since the early 1990s over a number of decades at significant investment. In more recent years, infrastructural work along the N40 has tended to focus on maximising the efficiency and throughput of the corridor with a number of interchange grade separation schemes completed.

The present N40 has been formed by the following collection of schemes:

- Kinsale Road to Douglas Scheme – Junction 6 to Junction 8 opened in 1990;
- Douglas to Rochestown Scheme – Junction 8 to Junction 9 (interchange included) opened in 1992;
- Dunkettle Interchange (Junction 11) constructed as part of the Glanmire Bypass opened in 1993;
- Bandon Road to Kinsale Road Scheme – Junction 3 to Junction 6 opened in 1996;
- Jack Lynch Tunnel Scheme – Junction 9 to Junction 11 opened in 1999;
- N22 Ballincollig Bypass – linking N22 west of Ballincollig to Junction 1 and a link from Junction 1 to the R608 was also opened in 2004;

At this stage, in 2004, a high quality dual carriageway corridor sweeping around the southern environs of Cork City was formed. However a number of the junctions along the N40 corridor were at grade junctions which as traffic demand increased resulted in increasing levels of congestion and delay. In order to reduce delays at these junctions and along the corridor, a number of junction upgrade / grade separation schemes have been implemented since, namely:

- Signalisation of Dunkettle (Junction 11) in 2006;
- Upgrade of the Junction 6 (Kinsale Road Roundabout) to a grade separated arrangement in 2006;
- Upgrade of Junction 3 (Bandon Road Roundabout) and Junction 4 (Sarsfield Road Roundabout) to grade separated arrangements in 2013.

---

<sup>1</sup> This is an annual average daily traffic figure. When lower flows at weekends are discounted, annual average weekday traffic figures could be up to 10% higher than this.

In 2012, the various elements of infrastructure listed above, which had originally been part of the N25 route, were designated as the N40 via statutory instrument.

The Dunkettle Interchange (Junction 11) represents the last at-grade junction on the N40. An upgrade of Junction 11 (Dunkettle), which includes a free-flow arrangement was granted approval with conditions by An Bord Pleanála in 2013. It is anticipated that this scheme will proceed to construction in the coming years.

As demonstrated above, there has been considerable investment of Exchequer funds along the N40 corridor since 1990. The N40 corridor was effectively completed in 2004. It was only a short while after its completion, when it became apparent that there was a need to increase the throughput and enhance efficiency along the corridor. This resulted in a number of grade separation schemes. The upgrade of Junction 11 (Dunkettle) will be the last of these grade separation schemes. As such, the next logical step for the N40 corridor is to manage the demands.

### 1.3 Current Study Context

As indicated previously, in 2012 a proposal to upgrade the Dunkettle Interchange was prepared and submitted to An Bord Pleanála.

Traffic analysis undertaken as part of the supporting Environmental Impact Statement (EIS) for the interchange upgrade suggested that by 2031 traffic in the Jack Lynch Tunnel, under high traffic growth scenarios, could exceed 75,000 annual average daily traffic (AADT). Experience of traffic on the M50, following the completion of the upgrade works to that route in 2010, demonstrates that there can be significant traffic growth on urban orbital routes following upgrade works, far in excess of national or regional average growth rates.

The assessment undertaken by An Bord Pleanála of the Dunkettle Interchange Upgrade Scheme considered whether the upgrade was justified in light of anticipated traffic growth and potential bottlenecks elsewhere in the adjacent road network. In particular, An Bord Pleanála identified potential for the Jack Lynch Tunnel to act as a future constraint and highlighted the need for the tunnel in particular to be protected from unsustainable traffic growth. In his report to An Bord Pleanála, the assisting inspector advising the Bord on traffic matters associated with the Dunkettle Interchange Upgrade Scheme stated:

***It is recommended that no planning permissions with significant transportation impacts be granted when the capacity of the most critical element in the interchange, namely the Jack Lynch Tunnel, is at 90% of the level at which on-going congestion would occur.***

***The implication of such a condition would be that if 90% of the capacity of the tunnel was committed, then further permissions should not be granted until or unless further traffic management measures and modal shift were shown to have taken place which would release more capacity in the tunnel.***

The assisting inspector calculated that the capacity of the tunnel was 75,000 annual average daily traffic.<sup>2</sup>

Arising from the above, An Bord Pleanála placed the following condition on their approval to the Dunkettle Interchange Upgrade Scheme in 2013:

***The applicant shall provide for and adhere to the following requirements in the proposed road development:***

---

<sup>2</sup> This was based on a reasonable method of approximation of capacities, assuming that capacity is reached at a certain level of congestion. In reality, roads continue to operate even when severely congested, albeit at a lower level of service.

***(a) Following commissioning of the proposed road development, the National Roads Authority shall, at intervals not exceeding twenty four months, review and upgrade the regional traffic model. At each review the road authority shall, in addition to measurement of traffic flows and validation of the model, include specific inputs for extant grants of planning permission within the Cork Metropolitan area. It shall publish this traffic flow information on the website of the National Roads Authority, and***

***(b) Within six months of the date of the Board Order an automatic traffic counter shall be provided on a permanent basis on the N40 National Primary Road in close proximity to the Jack Lynch Tunnel to provide on-going recording and monitoring of traffic flows.***

***Reason: To provide for on-going monitoring and review of traffic flows on the road network at the interchange, in order to indicate capacity to facilitate traffic generated by additional development, having particular regard to the capacity constraints of the Jack Lynch Tunnel.*** (Emphasis added)

In respect of compliance with this condition, it should be noted that TII has developed the National Transport Model (NTpM) which covers the entire National Road Network. The NTpM has a base year of 2013 and is updated annually to reflect changes in traffic flow based on data from the network of Traffic Monitoring Units. The information from the annual update of the NTpM is contained within the TII National Roads Network Indicator Report available on the TII website<sup>3</sup>. In addition, Traffic Monitoring Units (permanent automatic traffic counters) have been installed on a number of sections of the N40 including the section between Mahon and the Jack Lynch Tunnel.

In light of the above, TII's experience with the M50 and the fact that traffic studies for the Dunkettle Interchange Upgrade Scheme identified that, under certain traffic growth scenarios, the threshold of 90% of the tunnel capacity (as identified by the An Bord Pleanála assisting inspector) could be reached within the next decade, it was recognised that future traffic demand on the N40 would need to be managed if the N40 and the Jack Lynch Tunnel were not to act as a constraint on development within the Cork Metropolitan Area.

In order to progress with this matter, the National Roads Authority (now Transport Infrastructure Ireland (TII)), in consultation with Cork City Council, Cork County Council and various other stakeholders, undertook a study to identify a scheme of indicative Demand Management Measures for the N40.

This report provides a summary of the work undertaken and describes the indicative scheme of measures identified. However it must be stressed that no decision to implement these measures has been taken. The implementation of any scheme (or elements thereof) at a future date will be dependent on Government policy and decision, as well as being subject to the relevant statutory processes and legislation.

## 1.4 Study Objective

In setting the terms of reference for this study, the following overarching objective was identified:

***Study Objective: developing a scheme of specific Demand Management Measures for the N40 which seeks to ensure the capacity along the N40 is protected as demand rises in the future.***

Following consultation with key stakeholders, this overarching objective was distilled into a number of N40 specific objectives against which potential demand management interventions can be tested and more information on this is provided in Section 4.

---

<sup>3</sup> Further detail on both the National Transport Model and National Road Network Indicators are available at <http://www.tii.ie/tii-library/strategic-planning/>

Apart from the potential upgrade of the Dunkettle Interchange, significant capital upgrade works to the N40 (such as providing additional lanes, upgrades to other junctions, new river crossing, etc.) did not form part of the study. The objective of this study is to consider how best use can be made of the existing infrastructure with modest, low cost / high value improvements and changes to local policy approaches which could potentially be delivered in the short to medium term<sup>4</sup>.

---

<sup>4</sup> Short term is defined as within the period 2020– 2025. Medium term is defined as within the period 2025 – 2030.

## 2.0 Policy Context

The potential provision of demand management measures along the N40 corridor is in keeping with a number of European, national, regional and local planning policy documents, discussed in detail in the following paragraphs.

### 2.1 Trans-European Transport Networks (TEN-T)

The strategic nature of the section of the N40 between Junction 9 (Bloomfield) and Junction 11 (Dunkettle) has been recognised by the EU and has been included within the TEN-T ‘Core’ network. The Trans-European Transport Networks (TEN-T) are a set of road, rail, air and water transport networks in Europe. There are two designations in the TEN-T network which have implications for the future management and improvement of the road network.

The ‘core’ TEN-T network will act as the backbone for transportation within the EU and will be supported by a ‘comprehensive’ network of routes, feeding into the core network at regional and national level. The aim is to ensure that progressively, throughout the entire EU, the TEN-T will contribute to enhancing internal markets, strengthening territorial, economic and social cohesion and reducing greenhouse gas emissions.

Regulation (EU) No 1315/2013 sets out the requirements for high quality roads that shall form part of the TEN-T road network, both Core and Comprehensive, and states under Article 17(3), the following:

*“High-quality roads shall be specially designed and built for motor traffic, and shall be motorways, express roads or conventional strategic roads.*

*(a) A motorway is a road specially designed and built for motor traffic, which does not serve properties bordering on it and which:*

*(i) is provided, except at special points or temporarily, with separate carriageways for the two directions of traffic, separated from each other by a dividing strip not intended for traffic or, exceptionally, by other means;*

*(ii) does not cross at grade with any road, railway or tramway track, bicycle path or footpath; and*

*(iii) is specially sign-posted as a motorway.*

*(b) An express road is a road designed for motor traffic, which is accessible primarily from interchanges or controlled junctions and which:*

*(i) prohibits stopping and parking on the running carriageway; and*

*(ii) does not cross at grade with any railway or tramway track.*

For the core network, Article 39(2)(c) requires that only motorways or express roads shall be used.

In addition, Article 4 of the directive sets out the objectives of the TEN-T network including demonstrating European added value through (a) cohesion, (b) efficiency, (c) sustainability, and (d) increasing the benefits for its users. In particular, the following sub-articles are relevant to this study:

*Cohesion through:*

*(a) (iii) For both passenger and freight traffic, interconnection between transport infrastructure for, on the one hand, long-distance traffic and, on the other, regional and local traffic;*

*Efficiency through:*

- (b) (i) the removal of bottlenecks and the bridging of missing links, both within transport infrastructures and at connecting points between these, within Member States' territories and between them;*
- (iv) the promotion of economically efficient, high-quality transport contributing to further economic growth and competitiveness;*

*Increasing the benefits for users through:*

- (d) (ii) Ensuring safe, secure and high-quality standards, for both passenger and freight transport.*

Article 10 of the directive sets out the general priorities in the development of the comprehensive network and in particular states:

*In the development of the comprehensive network, general priority shall be given to measures that are necessary for:*

- (b) ensuring optimal integration of the transport modes and interoperability within transport modes;*
- (c) Bridging missing links and removing bottlenecks, particularly in cross-border sections;*
- (d) Promoting the efficient and sustainable use of the infrastructure and, where necessary, increasing capacity.*

In May 2017 the European Commission published the first part of its proposals for the EU Road Transport Strategy (the so-called “mobility package”) with the aims of improving environmental, social, efficiency and innovation aspects of road transport and as part of this there are a number of proposed changes to the area of tolling and road user charging which could influence demand management schemes on the TEN-T Network. Some of the potentially relevant changes include the promotion of more distance based user-charging / tolling and the phasing out of time-based charges as well as the simplification of the external cost components of charging schemes and option of a congestion charge element.

This, for example, could encourage a shift towards tolling / charging schemes on the basis of CO2 emissions (with significant reductions for zero emission vehicles), air pollutants and time of demand / congestion levels in addition to the charging component for the more conventional infrastructure cost contribution.



## 2.2 Smarter Travel, A Sustainable Transport Future 2009 - 2020

Smarter Travel sets out a broad vision for the future and establishes national transport vision and objectives. The main objectives focus on reducing the dependency on private cars by increasing the public transport mode share and encouraging walking and cycling. The policy contains a target to increase the number of commuters travelling to work via alternative modes to the private car that will lead to a drop in the total share of car commuting from 65% to 45%.

The policy acknowledges that *“transport is vital for our economy. As an island nation we need good transport connections with our trading partners; we also need to ensure efficient movement on the island. Safe and comfortable travel is also a key element of a good quality of life. The issue is not to restrict travel and transport but to facilitate smarter ways of meeting these needs”*.

Key actions set out in the policy to achieve this vision include:

- Actions to reduce distance travelled by private car and encourage smarter travel, including focusing population growth in areas of employment and to encourage people to live in close proximity to places of employment and the use of pricing mechanisms or fiscal measures to encourage behavioural change
- Actions aimed at ensuring that alternatives to the car are more widely available, mainly through a radically improved public transport service and through investment in cycling and walking.

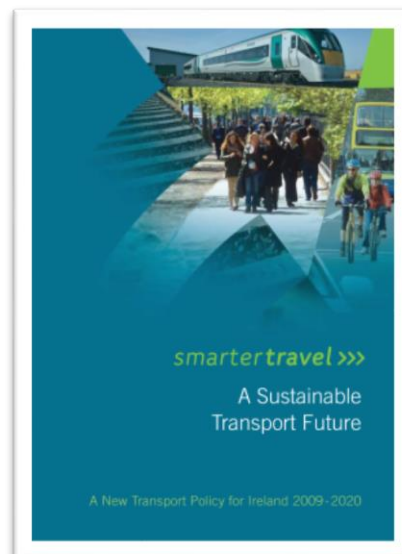

## 2.3 Strategic Investment Framework for Land Transport

In 2015 the Department of Transport, Tourism and Sport (DTTAs) published ‘Investing in our Transport Future - Strategic Investment Framework for Land Transport (SIFLT)’. The document recognises that even with better spatial planning and appropriate transport and walking provision, demand growth will erode the economic efficiency of the existing transport system, in particular in or near major urban areas. There is a focus on the important role of network management, maximising operational capacity, minimising safety risks and ensuring that maximum value is derived from the currently existing system. Therefore the policy of SIFLT is to encourage consideration of maximising the value of the current transport system along with major infrastructural investment projects.

This framework provides a number of principles and priorities as criteria against which land based transport programmes will be drawn up and assessed in the coming decades. Rather than setting out a list of projects to be prioritised, SIFLT forms a filter for transport investment projects prior to their appraisal for suitability for inclusion in national/regional programmes. These priorities include:

- Priority 1: Achieve Steady State Maintenance;
- Priority 2: Address Urban Congestion;
- Priority 3: Maximise the Value of Existing Land Transport Networks.

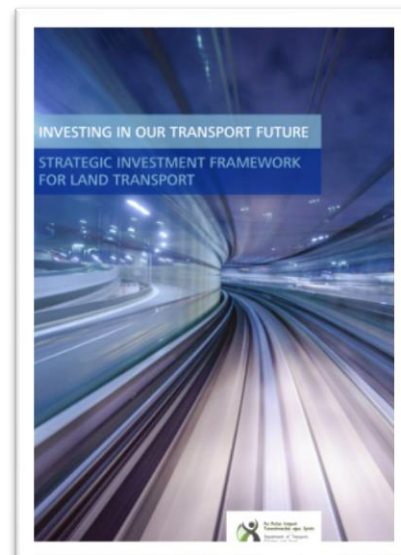

As mentioned previously, the N40 corridor is a strategic two lane dual carriageway; some sections of which has been in service since the early 1990's. Significant Exchequer investment has been directed towards the N40 since then.

Priority 2 and 3 of the SIFLT is therefore particularly relevant in the context of proposals for demand management along the N40 corridor. The underlying principles of these priorities are that any further investment should be targeted to maximise the contribution of the land transport networks by enhancing the efficiency of the existing network, particularly:

- Through increased use of ITS applications;
- Through investments that improve connections to key seaports and airports or support other identified national and regional spatial planning priorities;
- In the case of roads, investment should provide access to poorly served regions, access for large-scale employment proposals, complete missing links or address critical safety issues.

#### 2.4 National Ports Policy 2013

The core objective of the DTTaS National Ports Policy is to facilitate a competitive and effective market for maritime transport services. The long-term international trend in ports and shipping is towards increased consolidation of resources in order to achieve optimum efficiencies of scale. This has knock-on effects in terms of vessel size, the depths of water required at ports and the type and scale of port access and hinterland transport connections.

The National Ports Policy has provided a categorisation based on the national importance of ports. Tier 1 Ports are the top of the hierarchy and three ports are identified which fulfil the Tier 1 criteria, namely:

- Dublin Port;
- Port of Cork; and
- Shannon-Foynes Port.

The National Ports Policy clearly identifies as a matter of reasonable priority the improvement of the road and rail freight connections to the Port of Cork. This is reinforced in TEN-T network where port access and hinterland connection priorities are included as part of the core network. These priorities are both road and rail links.

The policy recognises that for inclusion in the core network, ports must enjoy significant volumes of freight and/or passenger traffic, have a high level of international connectivity and, by 2030, be connected to the core European rail and road network.

The provision of the core road to support the Tier 1 port status of the Port of Cork is therefore recognised as a key objective of the policy.

#### 2.5 Spatial Planning and National Roads, Guidelines for Planning Authorities (2012)

Statutory Government policy relating to the safety, efficiency and capacity of the National Roads network is set out in the Department of Environment document entitled "*Spatial Planning and National Roads*" published in January 2012. In essence this seeks to ensure that local authorities adopt policies that avoid the undermining of the strategic transport function of National Roads by promoting local transport infrastructure measures intended to cater for the roads needs of local traffic and local development related traffic.

Strategic traffic, in the context of National Roads, primarily comprises major inter-urban and inter-regional traffic. This inter-urban and inter-regional traffic, whether HGV, car, public transport bus services or other public service vehicles, contributes to socio-economic development and the transportation of goods and products, especially traffic to/from the main ports and airports, both freight and passenger related.

## 2.6 Cork City Development Plan 2015 - 2021

The Cork City Development Plan (CDP) 2015 – 2021 contains a number of objectives to support development of the metropolitan area over the coming years. Within the CDP, Cork City Council have set population targets for 2022 of approximately 150,000 inhabitants, an increase of approximately 19% on the 2016 population recorded within the Census. Furthermore, the CDP sets a target of 16,000 additional jobs within the Council jurisdiction which represents almost 22% increase upon the current job provision (2011 Census data) within the City.

Notwithstanding the above, the Cork CDP acknowledges that: *'In the past a considerable amount of development in Cork City and the Metropolitan Area (e.g. satellite towns) has been designed in a manner that is dependent on the national roads network. However, in recent years a roads hierarchy has been clarified, and the primary purpose of the national road network has been clearly defined as providing strategic movements of goods and people between major cities and regions and between key international gateways such as the main ports and airports (Ministerial Guidelines Spatial Planning and National Roads, January 2012).'*

Following on from the above the Cork CDP sets out a strategic objectives:

5.32 *Reserving adequate capacity for strategic traffic on the national roads network will require providing alternative means of access for existing development that was constructed around the national roads network, as well as limiting the extent of future development in locations that would give rise to the generation of short trip/ commuter traffic on national roads. Altering such patterns will require close cooperation with Cork County Council as part of the Cork Area Strategic Plan.*

5.33 *It is a strategic objective of Cork City Council to protect the capacity, efficiency and safety of national roads and associated junctions while maintaining the economic vibrancy of Cork City.*

## 2.7 Cork County Development Plan 2014

The Cork County Development Plan (CoDP) sets out the framework for the future development of the area. The CoDP sets population targets for 2022 of 470,622, an increase of approximately of 13% on the 2016 population recorded within the Census. The Cork CoDP also breaks out population targets into some regions. Of note for instance is the targets for the Greater Cork Ring. The Greater Cork Ring lies outside Metropolitan Cork and includes the towns of Mallow, Bandon, Fermoy, Kinsale, Macroom and Youghal. The target for Greater Cork Ring is 131,882, an increase 11% on the 2011 population recorded within the Census.

The Cork CoDP recognises that the N40 is *'a critical national road artery serving Cork City and connections to Cork Airport, Port of Cork, Ringaskiddy, Cork Science Park, West Cork and South Kerry'* and notes that the *'N40 Demand Management Study will look at all options for the management of the N40 including both controlling traffic on the route and managing the demand for traffic to use the road as well as possible targeted infrastructure improvement to ensure the capacity is protected over its design life as future planned demand rises'*.

## 3.0 Need for Demand Management

### 3.1 Overview

This section of the report provides a description of the existing situation along the N40 corridor in relation to the demand for travel. Population and employment data from the 2011 CSO Census is presented alongside traffic flow data. The traffic flow data has been extracted from TII permanent Traffic Monitoring Units (TMU's) in the Study Area; and from the 2013 base year N40 traffic model developed as part of this study.

### 3.2 Population & Employment

In order to understand the demand for travel on the road network, a review of the population densities and employment levels in the study area was undertaken. Figure 3.1 provides a plot of the population in both Cork City and Cork County since 1996.

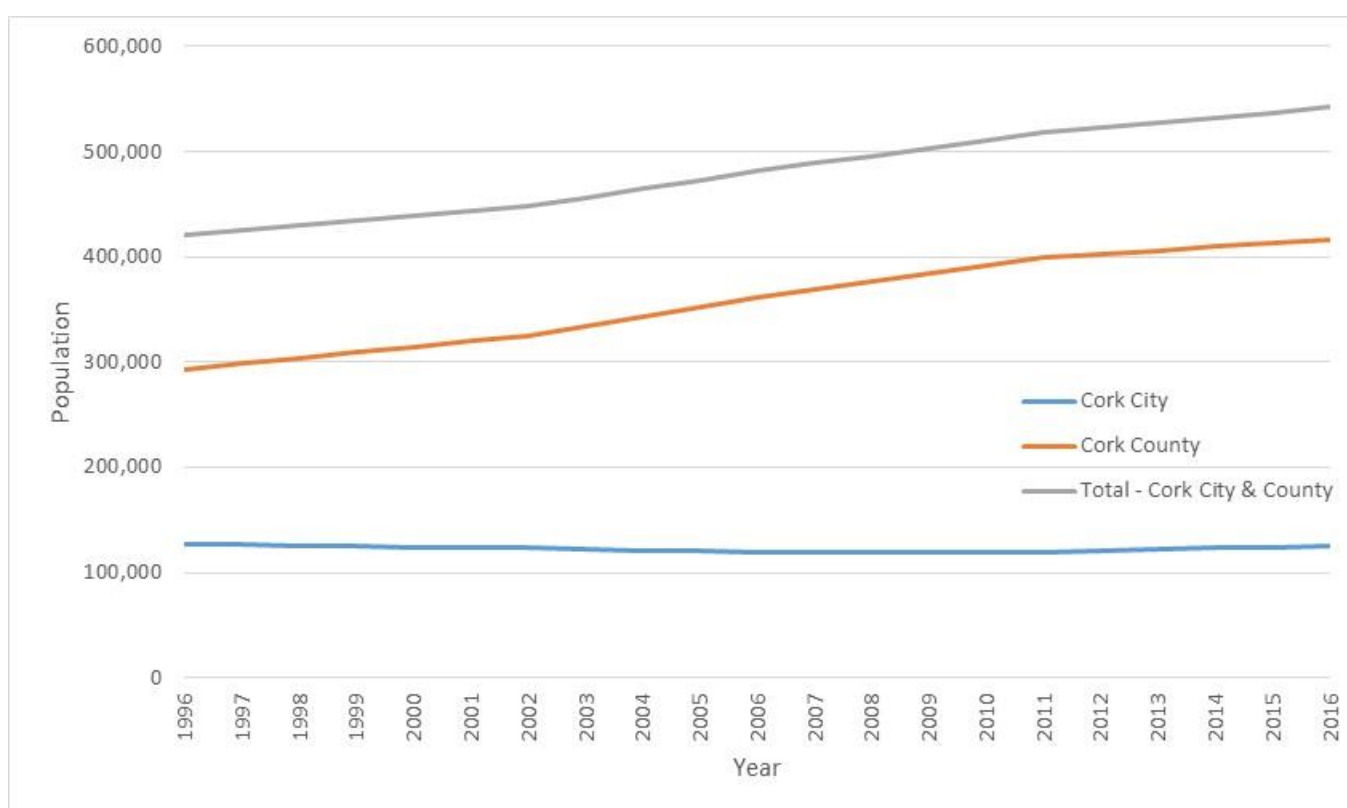
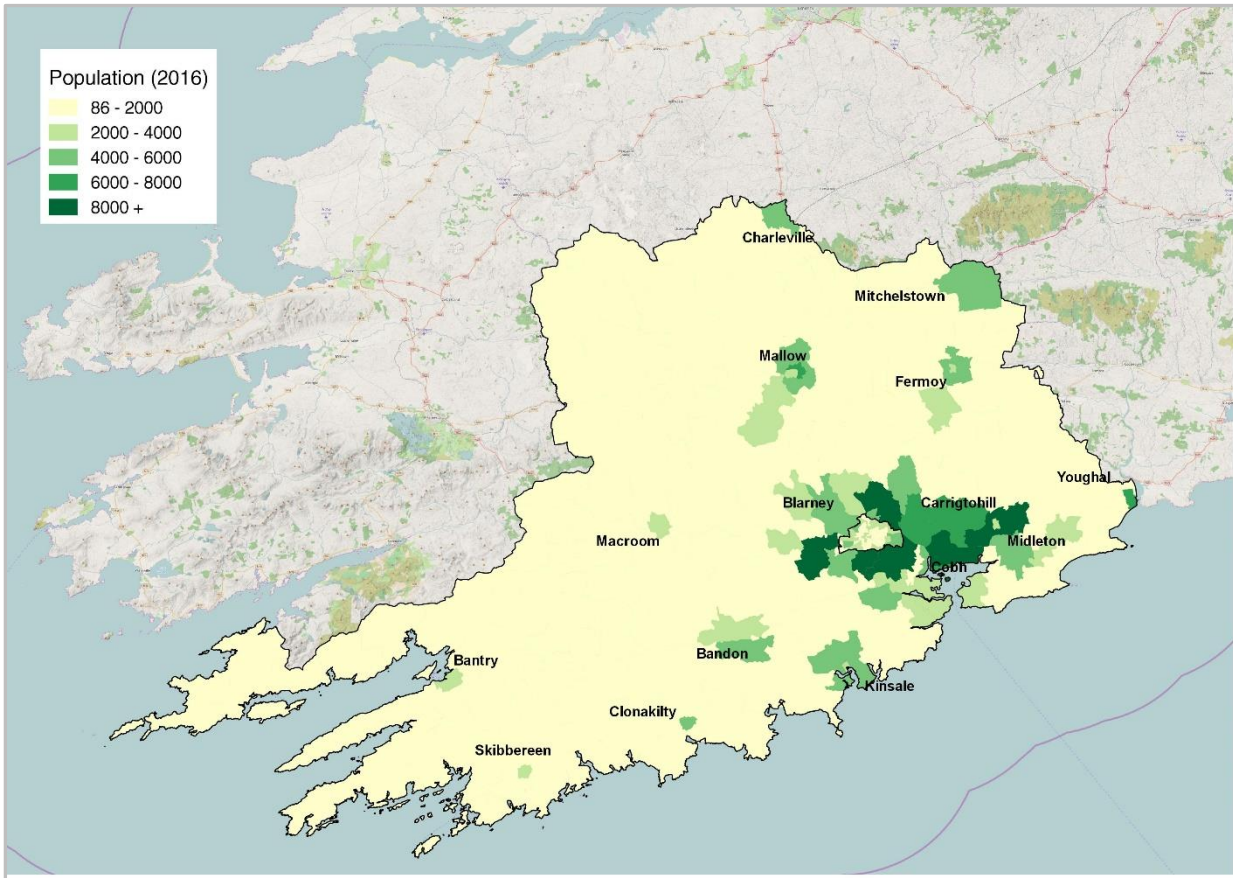

**Figure 3.1 – Population of Cork City & Cork County (1996-2016)**

During the period 1996 – 2016, there has been a significant increase in the population within the County of Cork (excluding the City). In contrast the population of the City has remained broadly similar since 1996, indeed between 1996 and 2016, there has been an overall decrease in the population of the City area of 1.2%.

With respect to the Cork County area, between 2002 and 2011 (the most profound growth period), there was an average annual population growth to the order of 2.3%. Despite the recent economic downturn the Cork County area has continued in population growth to 2016 to the order of 1% per annum.

Figure 3.2 shows a plot of population distribution in County Cork, taken from the 2016 CSO Census at Electoral Division level.

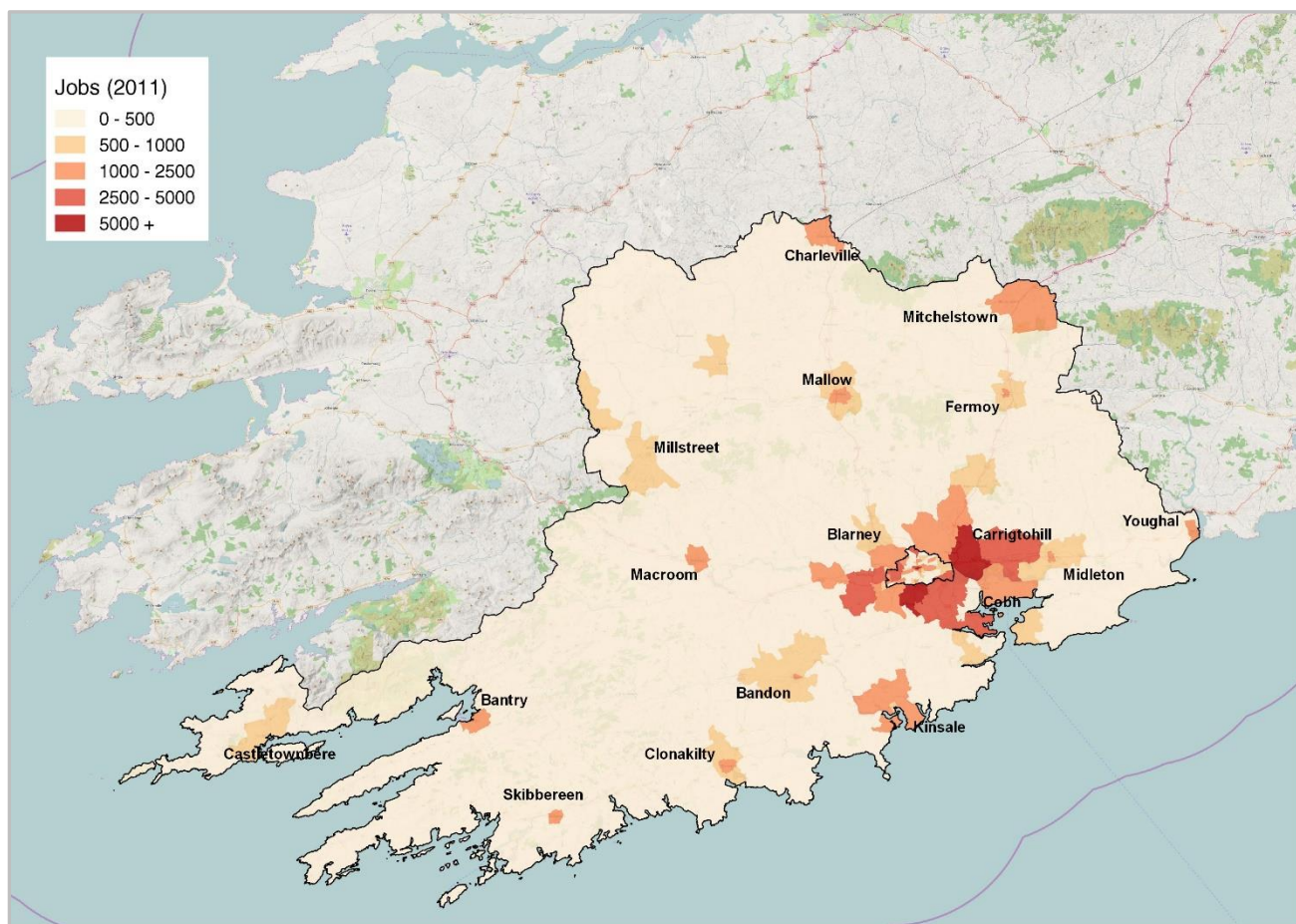

**Figure 3.2 – Distribution of Population in Cork County (2016)**

The population distribution map highlights the main urban areas in the study area surrounding Cork City, most notably the areas of Cobh, Midleton, Mallow, Youghal, Bandon and Kinsale; and areas in closer proximity to the Cork City jurisdiction including Douglas, Maryborough, Rochestown, Little Island, Mahon, and Ballincollig.

The plot emphasises the proximity of some of these main population areas to the N40 corridor. Thus, a significant portion of traffic demand on these sections of the N40 is associated with trips between these areas and destinations either in Cork City or in other areas accessed via the N40.

A similar plot of the jobs in each CSO electoral division in Cork City & County, taken from the 2011 Census is presented in Figure 3.3.



**Figure 3.3 – Distribution of Jobs in Cork City & County (2011)**

The plot emphasises the concentration of jobs in Cork City and surrounding areas such as Little Island, Cork Airport, Mahon, Carrigtohill, Ringaskiddy and Ballincollig. This data indicates that the potential for jobs in close proximity to residences is limited, particularly in the satellite towns to Cork City, and that many residents in these towns and villages will potentially be drawn to Cork City and areas beyond, potentially accessed via the N40, in order to pursue work in larger urban centres.

### 3.3 Existing Traffic Flows, Patterns & Behaviour

#### 3.3.1 Overview

Following on the trends and targets in population and employment and in order to better understand traffic movement and patterns in the environs of the N40 a traffic model was developed (N40 DMS Model). The N40 DMS Model, developed specifically for this project, was derived from the Cork Area Strategic Plan SATURN Model (as amended and updated for the Dunkettle Interchange Upgrade design). The N40 DMS was developed with particular focus on the N40 Corridor and is calibrated to 2013 traffic data.

The data used in developing the model includes a series of traffic surveys undertaken during 2010 / 2011<sup>5</sup> and more recently in 2013 along the full corridor. These surveys are supported by more recent data that is available through the permanent traffic monitoring units that are in place along the N40 since March 2013. Additional information, collected by Cork County Council as part of the Douglas LUTS study and by the Port of Cork as

<sup>5</sup> As part of the Dunkettle Interchange Upgrade Scheme

part of their planning work, was also made available. The following traffic data was available for the purpose of this study:

- Automatic Traffic Counts (2013);
- Manual Classified Link Counts (2013);
- Classified Junction Turning Counts (2013);
- Journey Time Surveys (2013);
- TII TMU traffic count data (continuous from March 2013);
- TII TMU vehicle speed data (continuous from March 2013);
- Historic TII traffic count data (post 2003);
- Existing SATURN model (containing pre 2013 traffic data); and
- Existing S-Paramics model.

### 3.3.2 Traffic Flows

Figure 3.4 below shows the 2013 traffic flows expressed in terms of Annual Average Daily Traffic (AADT). As can be seen, the highest traffic flows were recorded between Sarsfield Road Interchange and Bloomfield Interchange (73,000 – 76,000 AADT), with traffic flows between the Bloomfield Interchange and the Dunkettle Interchange reducing to approximately 59,000 AADT. Traffic flows to the west of Curraheen Interchange decrease to less than 27,000 AADT.

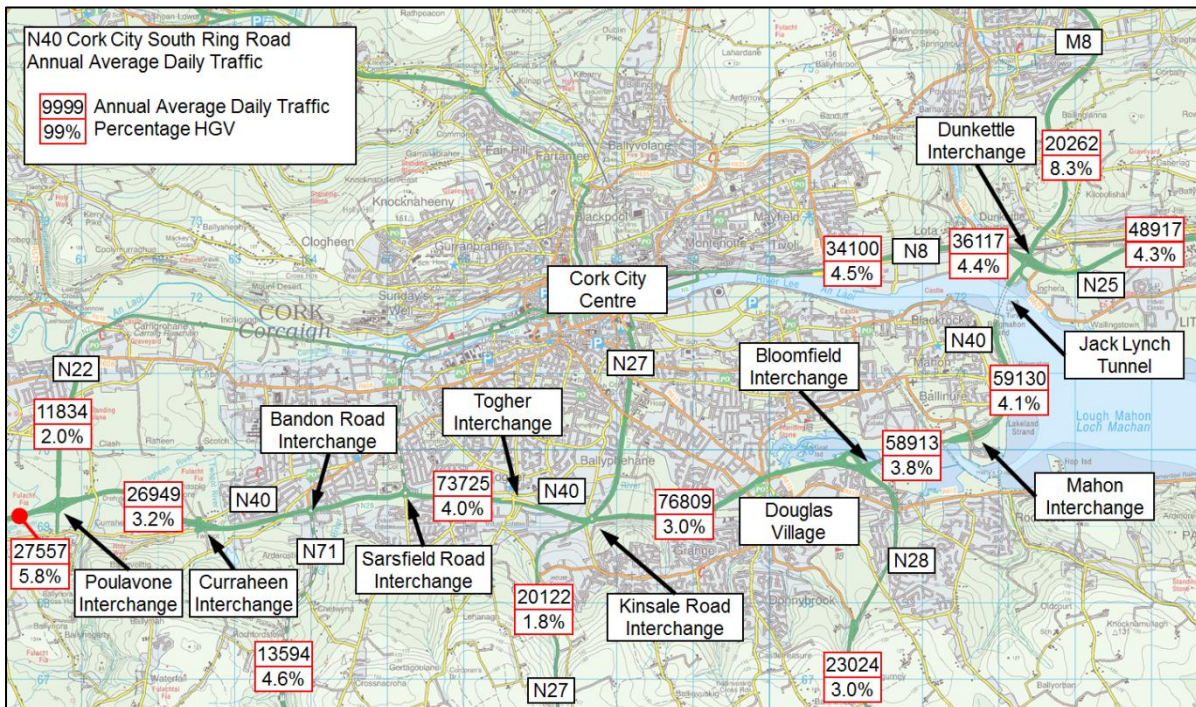

**Figure 3.4 – N40 2013 AADT Flows**

Since the data outlined in Figure 3.4 was collated, TII has installed traffic monitoring units (TMUs) at four locations on the N40 (shown in yellow in Figure 3.5) and also on the N25 east of Dunkettle and the N22 west of Poulavone, near Ovens. The TMU locations are shown in Figure 3.5.





Location	2013 AADT	2016 AADT	% Change
<b>N25 at Little Island</b>	48,800	53,200	+ 9.0%
<b>N40 at Jack Lynch Tunnel</b>	59,100	65,000	+ 10.0%
<b>N40 between N28 &amp; Mahon</b>	58,500	69,500	+ 18.8%
<b>N40 between N27 and N28</b>	76,700	84,400	+ 10.0%
<b>N40 between N22 and N71</b>	33,300	39,800	+ 19.5%
<b>N22 at Ovens</b>	18,800	20,900	+ 11.2%

**Table 3.1: Traffic Growth on the N40 corridor between 2013 and 2016**

As can be seen in Table 3.1 there has been considerable growth in the flows observed along the N40 in the last number of years, reflective of the recent return to economic growth. This recent traffic growth also occurs during the peaks periods and emphasises the issues observed along the corridor in 2013.

Using the TMU data one can examine the profile of daily traffic along the N40 in both 2013 and 2016. Taking the TMU in the vicinity of the Jack Lynch Tunnel as an example, Figure 3.7 presents the average hourly throughput at 5min intervals for a week in October in 2013 and 2016.

Broadly speaking there has been an increase in throughput across the inter and PM periods. The AM and PM peaks are clearly identifiable, however flow breakdown is evident during each of the peaks. In both cases, the flow breakdown leads to the extension of the peak period. In addition to the above, both peak periods appear to commence earlier than they had in 2013.

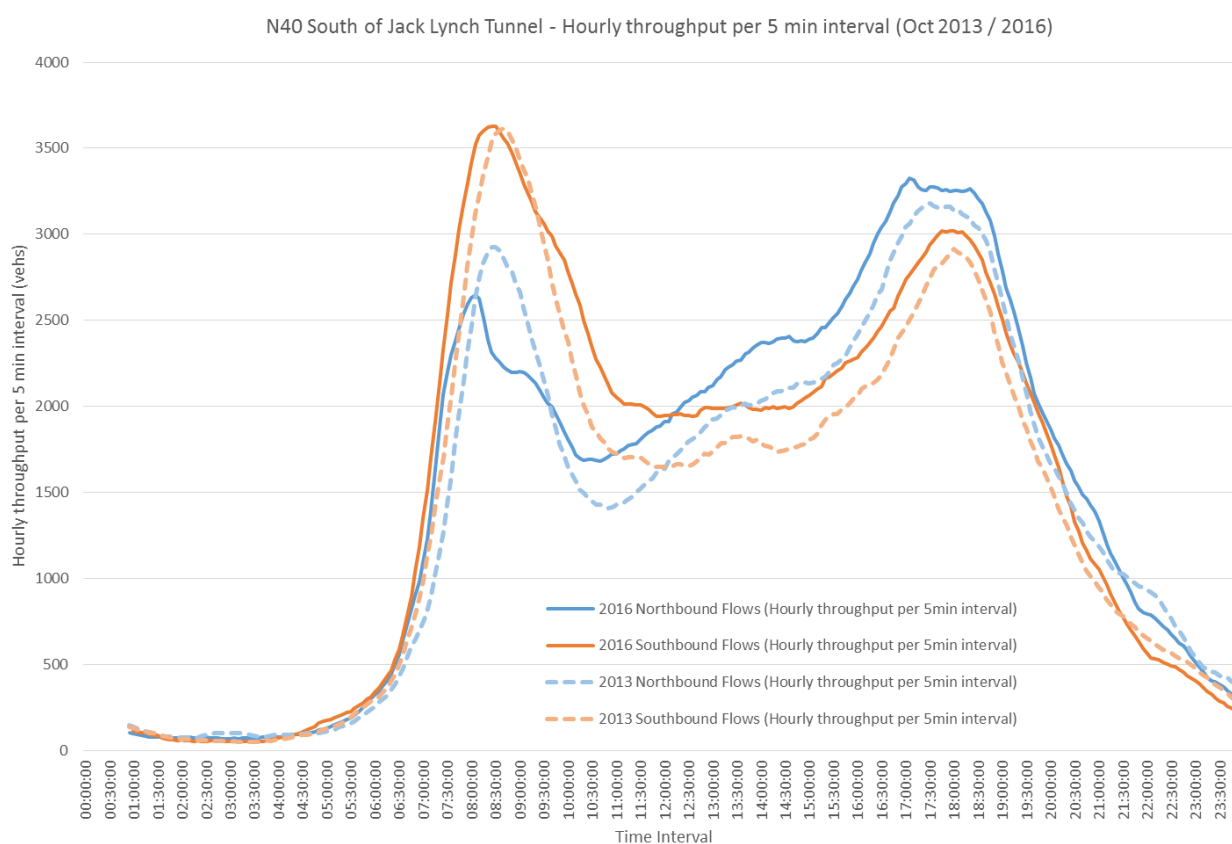

**Figure 3.7 –2013 and 2016 Daily Traffic Flow Profile on N40 at Jack Lynch Tunnel**

Taking the northbound flows (blue lines) in the 2016 AM peak, throughput approaching the Jack Lynch Tunnel has reduced significantly, indicating flow breakdown. It is also clear that the point of breakdown occurs at some stage between 07:30 and 08:00. It has the effect of suppressing throughput in the following hour and as a consequence peak spreading is also evident. In the PM peak a similar pattern is evident. While the throughput is higher there appears to be some turbulence in throughput which would suggest the effect of flow breakdown is evident. The capacity of this northbound section of the N40 is clearly influenced by the operation of traffic signals at Dunkettle. In the AM peak, breakdown occurs at approximately 2,600 vehicles per hour, however in the PM Peak breakdown occurs at approximately 3,300 vehicles per hour.

In the southbound direction there has also been growth in traffic across most of the day. However, there is limited evidence of breakdown; but as with the northbound direction there is clear evidence of peak spreading.

Using the TMU data it is also possible to look at the impact of traffic flows on speeds on the N40 in the vicinity of the Jack Lynch Tunnel. The mean spot speeds of traffic are also plotted at 5 min intervals and shown in Figure 3.8.

Taking the northbound flows (blue lines) the impact of flow breakdown is clearly shown. In the 2016 AM peak, mean spot speeds begin to reduce from 07:00 to a low of 20kph. Speeds begin to recover at 09:00 and return to normal levels at 09:30. Comparing this profile with 2013, it is clear that the situation has deteriorated. The evidence of peak spreading and the impact of increased demand are also clearly evident. The profile in the PM peak is similar, with the signal operation likely impacting on mean speeds as priority is given to northbound traffic.

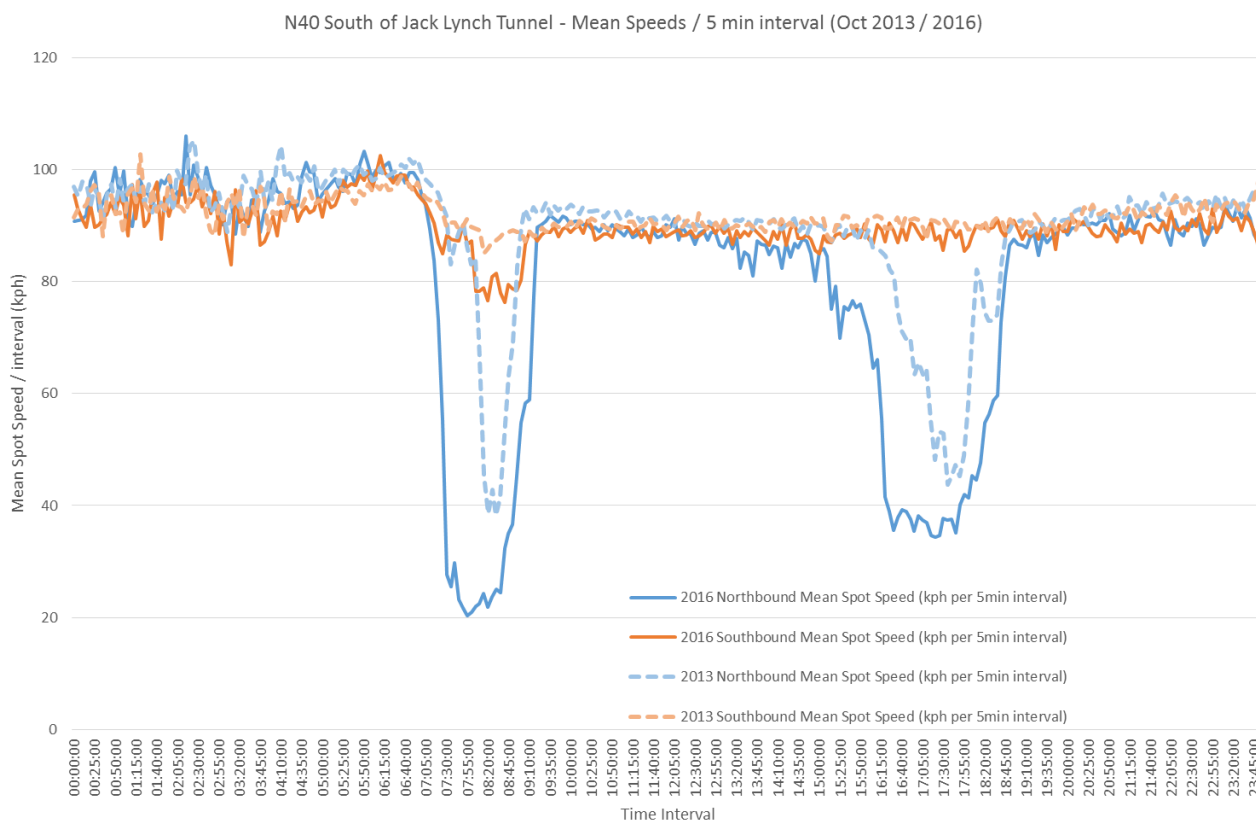

**Figure 3.8 –2013 and 2016 Mean Spot Speeds on N40 at Jack Lynch Tunnel**

A similar exercise has also been undertaken for the other TMU sites between Junction 9 (Bloomfield) and Junction 10 (Mahon) and between Junction 6 (Kinsale Road) and Junction 7 (Douglas West). These plots are shown in Figures 3.9 and 3.10.

Figure 3.9 also demonstrates a reduction in mean spot speeds in the eastbound direction. The mean spot speeds drop to the order of 70kph during the AM and PM peaks. It is likely that the issues downstream, in the vicinity of Jack Lynch Tunnel are having a ‘shockwave effect’ at this location east of Junction 9.

However, it is in the westbound direction at Junction 9 where downstream issues and congestion is having the greatest effect. Mean spot speeds in the westbound direction drop to 40kph during both the AM and PM peak periods. Again, it is likely that issues downstream, in this case perhaps in the vicinity of Junctions 7 (Douglas West) and 8 (Douglas East) that have a ‘shockwave effect’ at this location.

As with above, Figure 3.8 also demonstrates that there has been a considerable deterioration in congestion conditions along the N40 in the last number of years. Furthermore, this figure demonstrates that there are issues along the N40 in both directions during the AM and PM peaks.

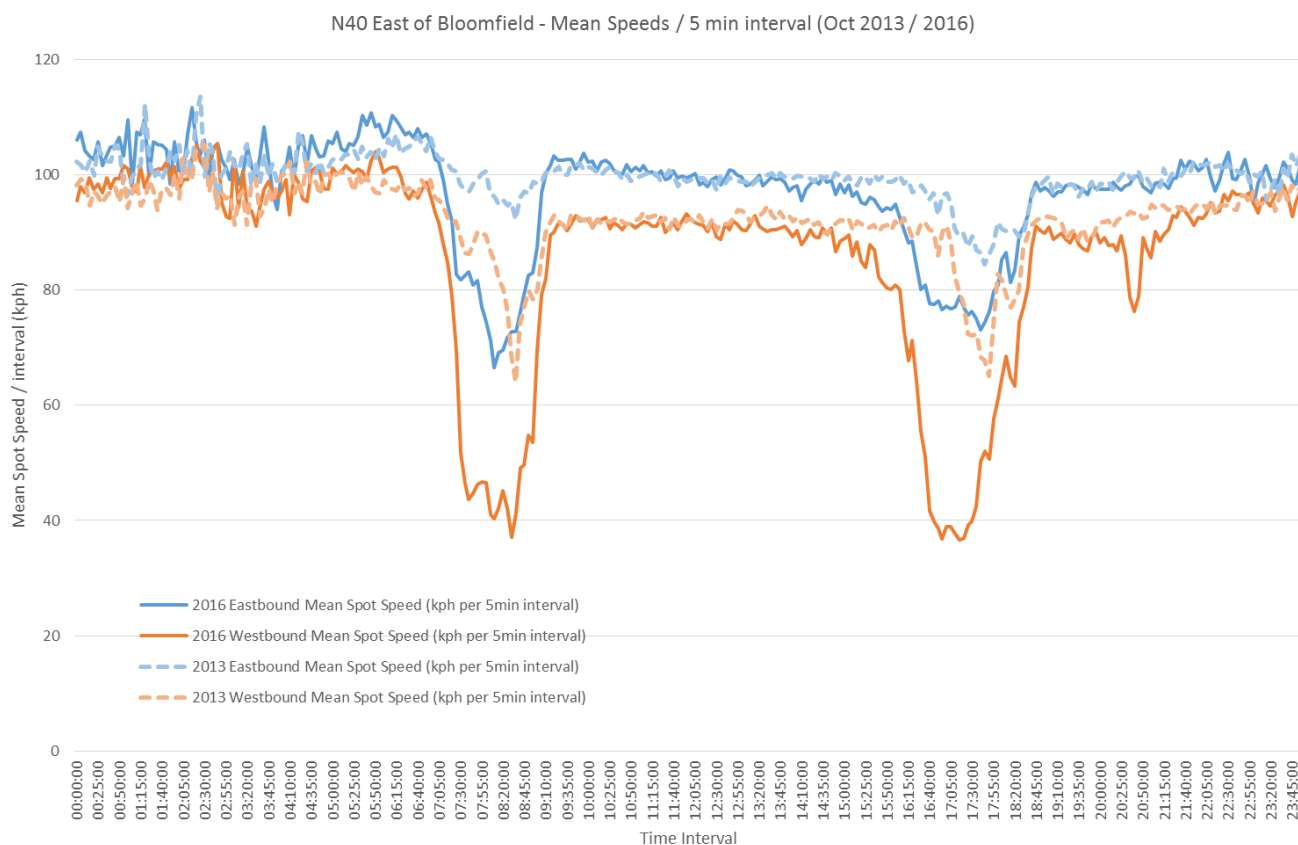

**Figure 3.9 –2013 and 2016 Mean Spot Speeds on N40 between Junction 9 and Junction 10**

Figure 3.10 demonstrates a reduction in mean spot speeds in the eastbound direction during the PM peak. In this direction, the mean spot speeds drop to the order of 50kph during the PM peaks. Again, it is likely that issues downstream, in this case perhaps in the vicinity of Junction 6 (Kinsale Road) that have a ‘shockwave effect’ at this location.

There is a modest reduction in the westbound mean spot speeds during the AM peak. However, the greater impact at this location is eastbound during the PM peak as mentioned above.

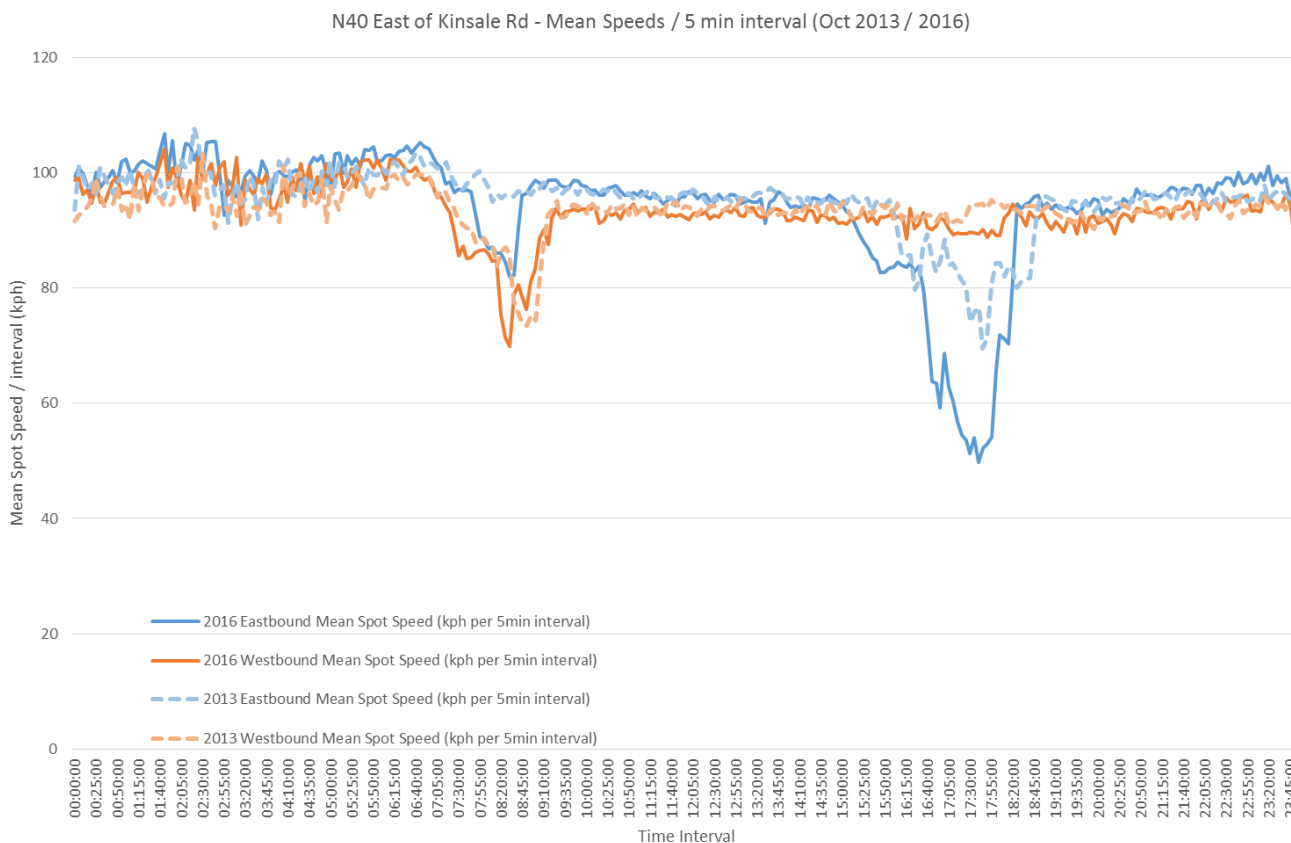

**Figure 3.10 –2013 and 2016 Mean Spot Speeds on N40 between Junction 6 and Junction 7**

### 3.3.3 Collision and Incidents

Traffic incidents can be a significant contribution to congestion particularly on high volume traffic routes. Historically only collisions have been recorded as incidents. However, based on TII’s monitoring of the road network it is clear that other incidents such as break downs, obstructions and debris are significant contributors to congestion and delay and can have a greater frequency than collisions. Indeed information from the M50 indicates that of the 120 incidents reported each month only around 50% are related to collisions. TII has begun to record all incidents on the N40 to assist in understanding the volume and nature of incidents over and above collisions. For the purposes of this study only information relating to collision is available

Data relating to collisions on the N40 which involved personal injury was received from the Road Safety Authority. The data was filtered to show only collisions that have occurred on the N40 (previously N25) between the Dunkettle Interchange and the Poulavone Interchange between 2000 (post Jack Lynch Tunnel completion) and 2011. Collision statistics in the vicinity of the Bandon Road and Sarsfield Road Interchanges were not included in the assessment as a result of the recent upgrades. Collision statistics pre-August 2006 in the vicinity of the Kinsale Road Interchange were not included as a result of the grade separation of the N40 at the interchange in 2006.

Table 3.2 details the total number of collisions along various sections of the N40 and outlines the rate of collisions per km for each section. The numbers in brackets include collisions at Kinsale Road Interchange signalised roundabout. It is apparent that there are four areas that have collision rates above the average for the entire route. These are:

- Between Dunkettle Interchange and Mahon Interchange;
- Douglas Village Flyover; and
- Douglas West Half-Diamond Interchange – Kinsale Road Interchange; and
- Kinsale Road Interchange (roundabout, on-ramps and off-ramps).

N40 Section	Number of Collisions	Collision Rate per kilometre
<b>West of Kinsale Road interchange (not including Bandon Road and Sarsfield Road Interchanges)</b>	3	0.7
<b>Kinsale Road Interchange and Approaches</b>	9 (17)	9 (17)
<b>Between Douglas Village and Kinsale Road Interchange</b>	8	8
<b>Douglas Village Flyover</b>	18	9
<b>Between Bloomfield Interchange and Mahon Interchange</b>	8	4
<b>North of Mahon Interchange including JLT</b>	15	7.5
<b>N40 Entire Route (excl. Bandon &amp; Sarsfield Interchanges)</b>	61 (69)	4.88 (5.52)

**Table 3.2: Collisions along the N40 (2000 – 2013)**

From this analysis, it is apparent that those areas of the N40 with higher traffic flows also have higher collision rates.

Figure 3.11 shows the total number of collisions compared with the average N40 two-way traffic over the course of a typical weekday. This also shows that collisions generally follow a similar trend to traffic volumes, with the frequency of collisions increasing during the AM and PM peak periods. The higher rate of incidents during these periods, indicates a strong connection between volumes and incidents. The fatal collisions are the most apparent outlier occurring at times when there is very low traffic volume on the network.

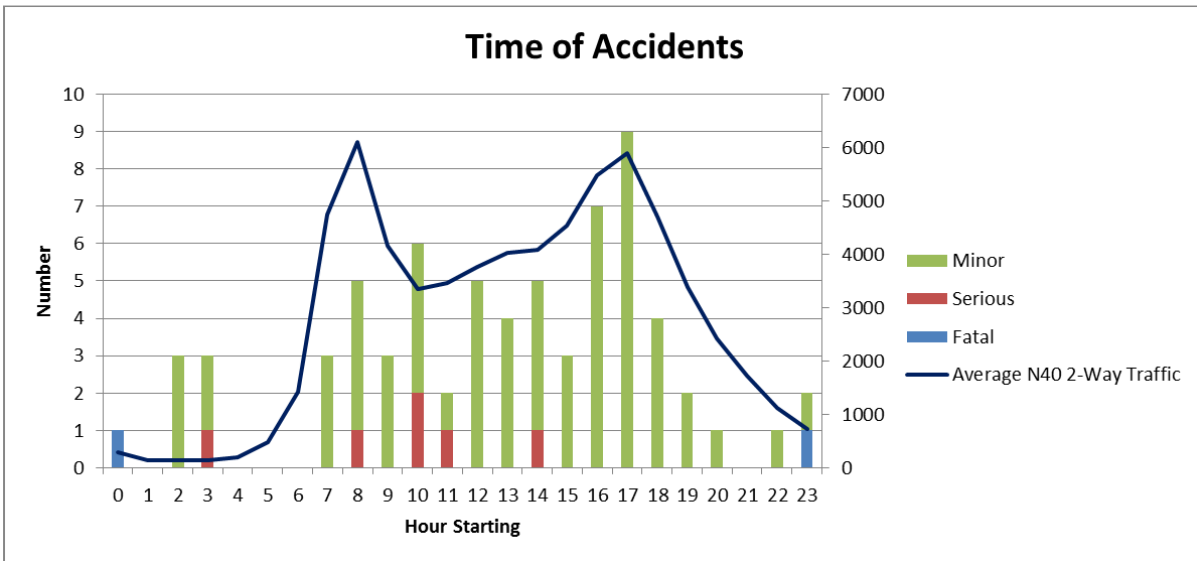

**Figure 3.11 – Frequency of Collision by Time of Day**

### 3.3.4 Practical Capacity of the N40

The N40 is a dual carriageway with grade separated junctions and varying cross sections which include auxiliary lanes on certain sections. A variety of factors can influence the capacity of a route including the junction frequency, queuing, weaving, merging and diverging effects

Previous research by the NRA<sup>6</sup> has found that the Practical Capacity of an unmanaged lane in a traffic stream can be defined at between 1,800 and 1,850 Passenger Car Unit's (PCU) per lane per hour (equates to approximately 1,700 vehicles/lane/hour).

The research showed that the practical capacity of an unmanaged land was measured at between 1,700 and 1,800 passenger car units (PCU) per hour, once traffic flow in an unmanaged lane exceeds these values flow can begin to breakdown.

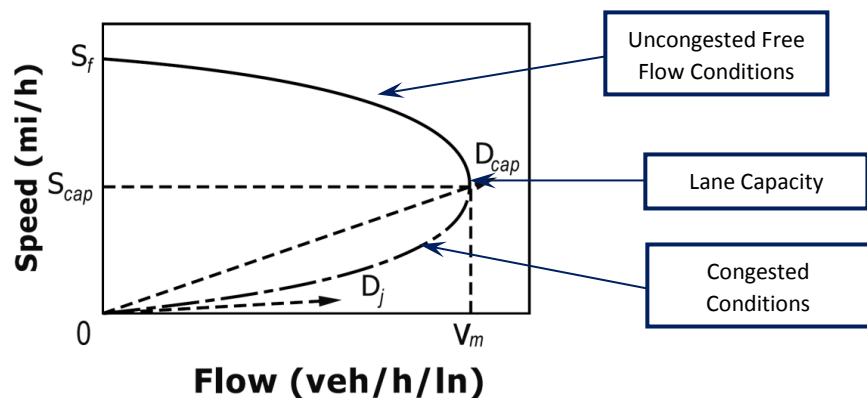
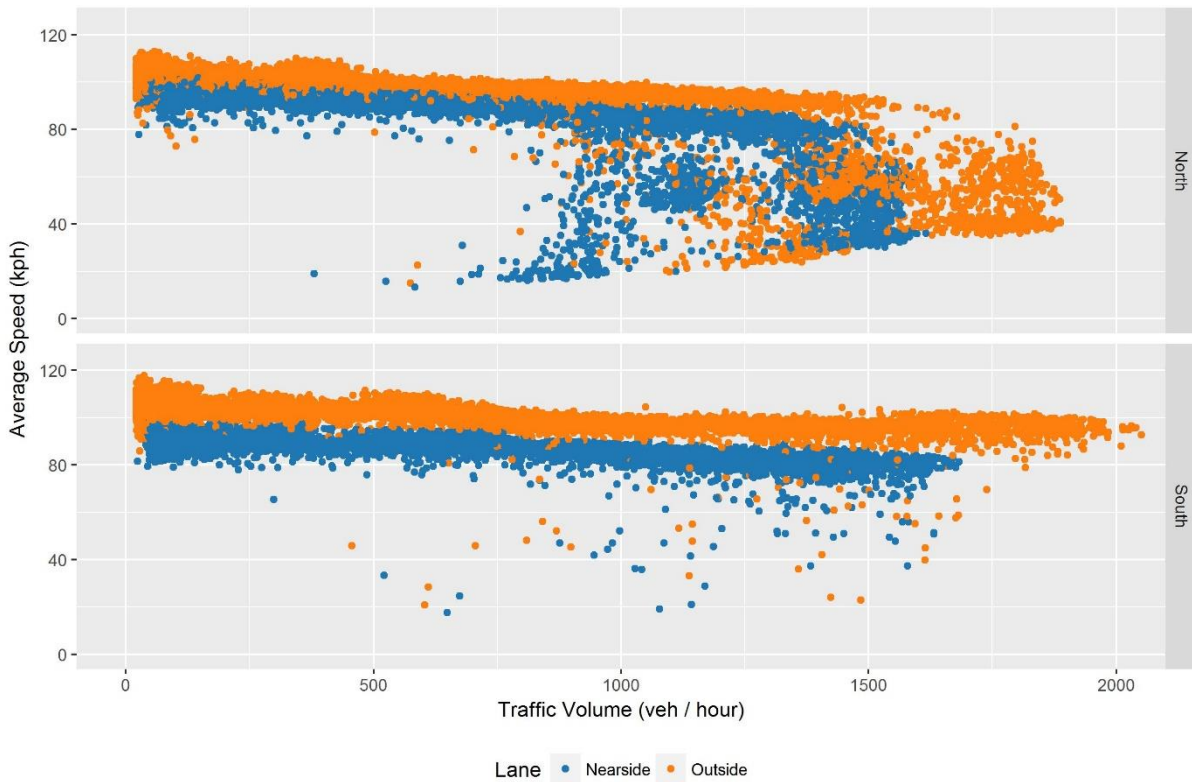

**Figure 3.12 – Generalised Speed Flow Relationship**

<sup>6</sup> A Study of Lane Capacity in the Greater Dublin Area: NRA: February 2012

The practical operating capacity mentioned above is based on aggregate actual data obtained from the traffic monitoring units and therefore the effect of other characteristics of the road such the junction frequency, queuing, weaving, merging and diverging effects are considered. However, when looking at specific sections of the network the influence of any other of these elements on the practical operating capacity result in increases or decreases of this threshold. Accordingly, an assessment of the relationship between speed and flow on different sections of the N40 was undertaken. Using the TMU per vehicle records for all weekdays in 2016 speed flow curves were developed. Figures 3.13 and 3.14 illustrates the Generalised Speed – Flow Relationship, indicating free-flow conditions, where lane capacity is reached and congested conditions.

The speed flow curves shown in Figures 3.13 and 3.14 each demonstrate two distinct curves within each section of the N40, the more constrained curve representing the nearside lane. Proximity to junctions, queuing back from downstream junctions and weaving, merging and diverging manoeuvres appear to have an impact on the capacity of nearside lane, whereas the outside lane appears to have a capacity somewhat comparable to the 1,700 vehicles mentioned above.



**Figure 3.13 – N40 Speed Flow Relationship between Junctions 10 (Mahon) and 11 (Dunkettle)**



**Figure 3.14 – N40 Speed Flow Relationship between Junctions 9 (Bloomfield) and 10 (Mahon)**

Utilising the speed flow relationships outlined above, the practical capacity of the busiest lane on congested sections of the N40 has been computed as follows.

Segment of N40	Practical Capacity (vehs / hr / lane)
Junctions 10 - 11	1,835
Junctions 6 - 7	1,770

**Table 3.3: Sample of Practical Capacities on the N40**

### 3.3.5 Traffic Flows on the N40 and Relationship to Practical Capacity

The Peak Period Traffic Volumes along the N40, and for some of the key routes that feed the N40, are illustrated in Figure 3.15 below. The figure shows both the AM and PM Peak Traffic Volumes, based on the workday average over the month of November 2013. It should be noted that the N40 does not have a single representative “Peak Hour” instead the peak hour traffic occurs at different times and at different locations on the N40 during the AM and PM Peak periods. For reporting purposes, a typical peak hour has been considered for the AM and PM peak periods of 8:00am – 9:00am and 5:00pm – 6:00pm.

As shown in Figure 3.15, significant hourly traffic flows arise on certain sections of the N40 particularly on both of the approaches to Mahon Interchange and Kinsale Road Interchange in the AM Peak and eastbound between Kinsale Road Interchange and the Douglas Interchanges / Bloomfield Interchange in the PM Peak. It is also worth noting that the proportion of daily traffic accounted for by peak hour activity is consistently around or above 10%, highlighting the dominance of commuting activity along the N40.



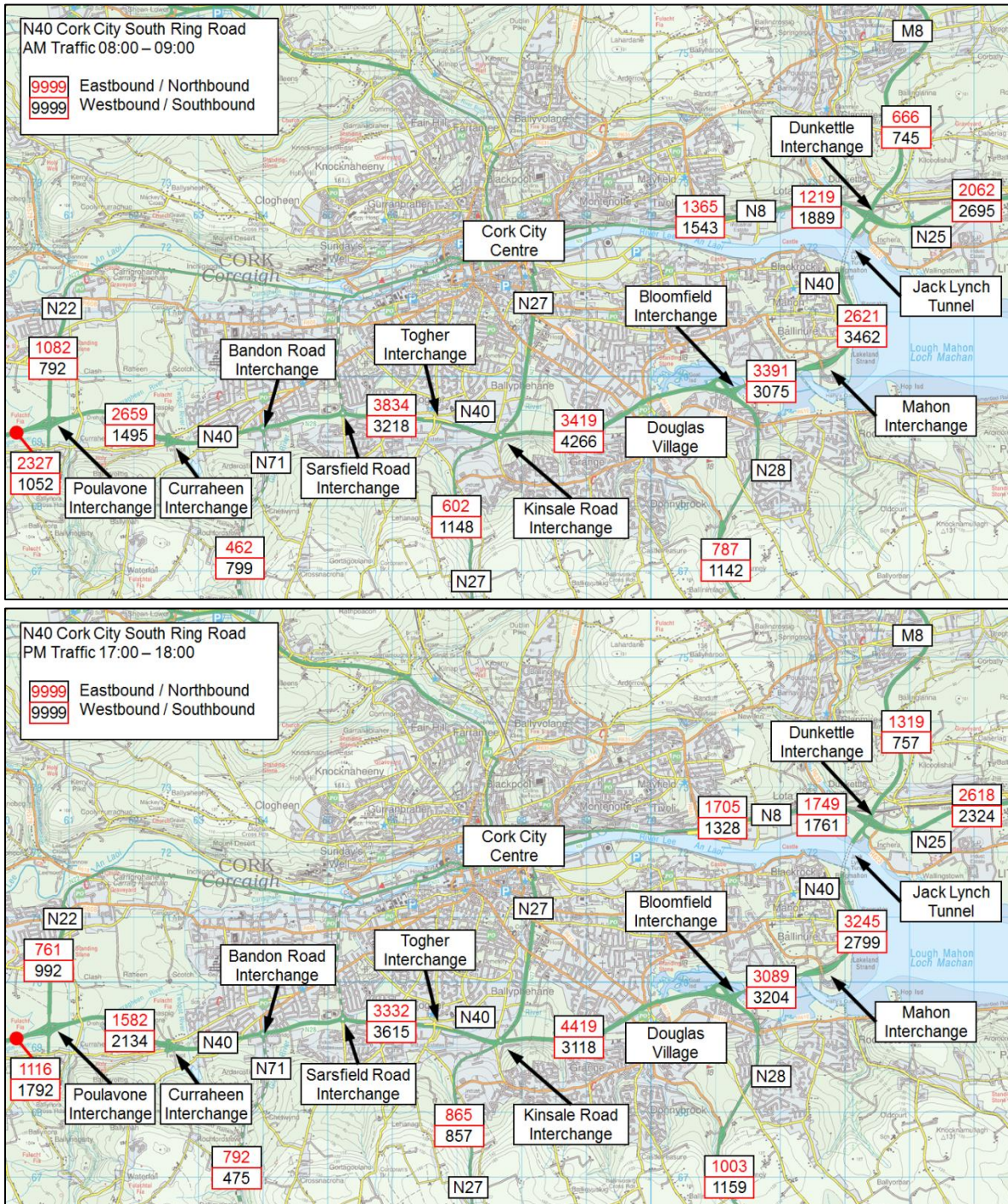

**Figure 3.15 – 2013 AM & PM Peak Hour Traffic Flows**

Taking the 2016 busiest lane flow in combination with the practical lane capacities outlined in Table 3.3, assessments of the volume over capacity on sample sections of the N40 can be made.

Section	Direction	Practical Capacity (vehs / hr)	AM Max. Lane Flow	PM Max. Lane Flow	AM V/C	PM V/C
Jn 10 - 11	Northbound	1,835	1,295	1,769	0.71	0.93
Jn 10 - 11	Southbound	1,835	1,704	1,593	0.96	0.87
Jn 6 - 7	Eastbound	1,770	1,334	1,541	0.75	0.87
Jn 6 - 7	Westbound	1,770	1,729	1,590	0.98	0.90

**Table 3.4: Assessment of peak volume over practical capacity on the N40**

In conclusion, the above analysis has identified that traffic flows along the N40 are high between Junctions 10 and 11, particularly in the peak periods. The volume over capacity ratio in the vicinity of the Jack Lynch tunnel has been measured in excess of 90% in both directions and there is a clear need to protect the remaining residual capacity to ensure the N40 completes its strategic function.

### 3.3.6 N40 Level of Service

Level of Service (LOS) is a description of the characteristic of a section of Dual Carriageway or Motorway, which outlines the traffic flow conditions along that section. LOS is defined to represent reasonable ranges in the three critical flow variables: flow, speed and density. The traffic conditions describing the six LOS are outlined in Table 3.5 below:

LOS	Density pcu/km/ln	Description
A	<7	Free-flow operations, manoeuvres unimpeded
B	<11	Reasonably free-flow operations, manoeuvres slightly restricted
C	<16	Flows near free-flow speed, manoeuvres noticeably restricted
D	<22	Decline in speed with increased flows, manoeuvres seriously limited
E	<25	Operation at capacity, little room to manoeuvre
F	>25	Unstable flow, low speeds, flow breaks down causing congestion

**Table 3.5 – Level of Service Criteria and Description**

Figure 3.16 details the average weekday density and LOS for traffic on the N40 obtained from the NRA TMU counters for the month of November 2013.

The N40 on the northbound approach to the Dunkettle Interchange operates at LOS F during both peak periods, due to capacity issues at the existing signalised roundabout element of the interchange. Southbound on this section of N40 operates at LOS C or D during the peak periods. During the inter-peak periods both directions are generally seen to operate at LOS C or lower.

Between Bloomfield Interchange and the Kinsale Road Interchange the N40 operates generally between LOS C and E. This section of N40 operates at LOS B or C during the inter-peak period. To the west of the Kinsale Road Interchange the N40 generally operates at LOS A or B.

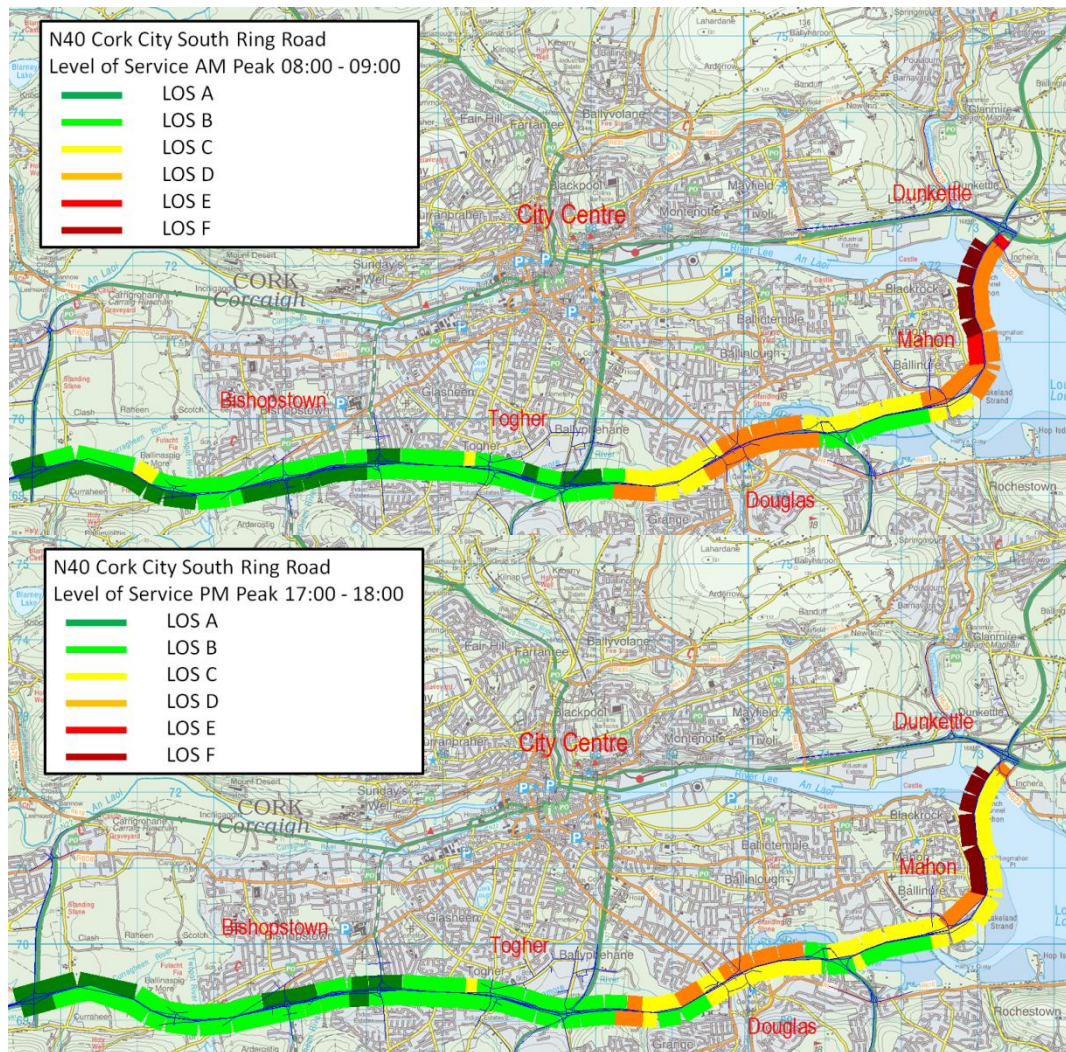

**Figure 3.16 – N40 Peak Period Level of Service**

### 3.3.7 Summary

The busiest sections of the N40 are currently carrying upwards of 85,000 vehs/day whilst peak period flows of up to 7,700 veh/hour are travelling along the Kinsale Road - Bloomfield section. An analysis of journey time and incident data has shown that the sections of N40 with the higher levels of traffic flow also have higher than average incident rates. When incidents do occur, the detrimental effect on journey times can be dramatic. The analysis confirms that a scheme of demand management measures are required to protect the role of the N40 as the hub of the National Roads network in the region and maintain its strategic role.

As such it is important that both the network operational issues experienced on the N40 and the level of likely future traffic growth on the N40 are understood. This understanding is required to ensure that the core function of the infrastructure is retained by actively influencing the decision making of existing and future users through demand management measures.

### 3.4 N40 Network Operational Issues

#### 3.4.1 Overview

In order to fully understand the reasons behind the congestion that is currently being experienced on the N40, a detailed microsimulation traffic model of the N40 and its junctions was prepared based on the model previously prepared and used for the Dunkettle Interchange Upgrade Scheme. This traffic modelling exercise demonstrated that the problems and issues experienced on the N40 can be sub-divided under the following headings:

- Junction Capacity Issues;
- Weaving Issues; and
- Merging & Diverging Issues.

Figure 3.17 illustrates the locations of operational issues on the N40 and these are discussed in more detail in subsequent paragraphs.

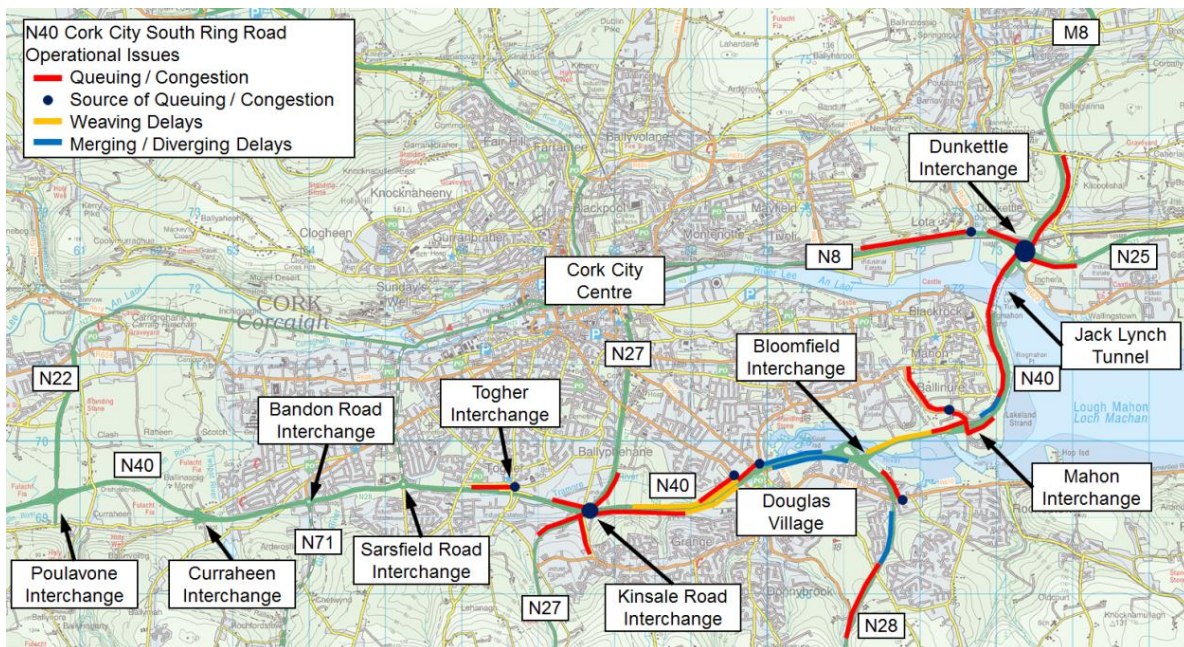

**Figure 3.17 – N40 Cork Southern Ring Road Operational Issues**

#### 3.4.2 Junction Capacity Issues

A factor that contributes significantly to delays and congestion on the N40 is the lack of junction capacity to carry the traffic demand. At numerous sites on and adjacent the N40, junctions reach capacity during the peak periods, resulting in traffic queues developing and extending onto the N40 carriageway.

The following lists the junctions that result in significant negative impacts for the operation / capacity of the N40:

- Dunkettle Interchange;
- Mahon Point Junction;
- Southbound Off-Ramp from Bloomfield Interchange to Rochestown Road;
- Eastbound Off-Ramp to Douglas Village;
- Eastbound Off-Ramp to Douglas West Half-Diamond Interchange;

- Kinsale Road Interchange; and
- Eastbound Off-Ramp to Togher Interchange.

This lack of junction capacity has the effect of causing traffic to queue from the junction back onto the N40. This primarily affects the N40 traffic by blocking one of the available lanes. In situations where auxiliary lanes exist at the junction and traffic doesn't block the N40 through lanes, as well as impacting on lane availability for traffic wishing to change lanes, the very fact that there is stationary traffic in an adjoining lane affects the behaviour of other drivers and reduces the ability of the N40 to carry the required traffic flows.

Within Building on Recovery, funding has been committed for the major upgrade of the Junction 11 (Dunkettle) interchange. In addition funding has been committed to bring the M28 Cork to Ringaskiddy scheme through planning and construction. Subject to planning this will address the issues experienced on the Bloomfield junction.

Any measures proposed as part of this study will be complementary to the development of these larger schemes.

#### 3.4.3 Weaving Issues

There are multiple sections of N40 carriageway that cater for significant levels of traffic weaving between interchange on-ramps and off-ramps on the N40 mainline. It is difficult to specifically identify and quantify the issues associated with weaving on these sections of the N40, as during peak periods queuing is experienced at these locations that results from capacity issues at adjacent junctions.

However, it is clear from the analysis and also from the observation of traffic flows along the N40 that weaving issues exist at all locations where merges and diverges are located in close proximity to each other and most notably westbound between Douglas West and Kinsale Road, eastbound between Kinsale Road and Douglas West and eastbound between Bloomfield and Mahon.

#### 3.4.4 Merging & Diverging Issues

Traffic flow breakdown is caused by high traffic flows from a number of on-ramps merging with traffic on the N40 at certain locations where the N40 is already heavily trafficked. The main location where this occurs is westbound at the Bloomfield Interchange. Some delays are experienced eastbound on the Douglas Village Flyover on the approach to the Bloomfield Interchange Off-Ramp, due to traffic changing lanes in order to exit the N40 at the Bloomfield Interchange on this heavily trafficked section of the N40.

### 3.5 Assessment of Future Growth

In forecasting future growth in traffic a number of elements have been considered which will drive increases in demand on the N40 such as population and employment growth brought about, in part, by the recent return to economic growth. In simple terms, future growth is defined by projecting population and GNP, which yields a network-wide traffic demand. The resulting increase in demand on the N40 and the future pattern of traffic is then assessed using the network models, namely TII's National Transport Model and the N40 DMS Model.

The projection of this traffic demand therefore incorporates assumptions on population and GNP growth. No additional variable demand response or 'induced demand' is assumed in the analysis.

The resulting growth pattern is presented in Table 3.6 below. This is based on TII Medium and High Growth scenarios for the future years of 2033 and 2048.

Forecast Year	Medium Growth			High Growth		
	AM	Inter	PM	AM	Inter	PM
2018	7%	6%	7%	8%	7%	8%
2033	29%	26%	28%	32%	28%	31%
2048	37%	37%	35%	44%	43%	42%

**Table 3.6 – Forecast Growth along N40 corridor**

Clearly, there are segments of the N40 which presently could not accommodate such levels in growth. As such, there is a need considering ways in which demand can be managed such that the road infrastructure does not constrain continued economic growth.

### 3.6 External Impact of N40 Conditions

#### 3.6.1 Journey Times

As the number of vehicles using the national road network increases, the level of service for all vehicles will decrease. In other words, adding additional vehicles to the national road network increases journey times for all users.

As traffic increases in the future, the impact of minor incidents will worsen resulting in increased journey times and congestion.

This imposes a real cost on road users and the economy as a whole. The marginal external cost of congestion (MECC) is defined as the difference between the marginal social cost and the trip maker’s own costs where the marginal social cost reflects the cost that is imposed on road users and society at large by an additional trip.

Charging road users an amount equal to the MECC is an effective means of influencing the demand for the road.

#### 3.6.2 Journey Time Reliability

Journey time reliability is heavily influenced by the stability of the traffic stream, with congestion leading to temporary bottlenecks and resulting delay to all road users. As congestion increases, journey times increase and the predictability of journey times decreases resulting in an additional cost to road users and the economy as a whole.

As traffic flows on the N40 increase, the influence of road space capacity will become more evident, in particular along sections downstream of egress/access points where capacity is constrained.

#### 3.6.3 Road Safety

Whilst the number of collisions on any section of road is a function of the number of vehicles using that road, it is also a function of the traffic behaviour on the road. On high capacity roads such as the N40, the number of collisions is expected to increase as a result of higher levels of lane switching / weaving that may take place during those periods when the carriageway is approaching congestion. This activity leads to stop-start driving as the demand within individual lanes fluctuates, which can lead to significant safety risks on roads operating at high speed.

### 3.6.4 Environmental Impacts

A further external cost of road use is the environmental damage from operating motor vehicles. These costs are imposed on the environment as a whole as opposed to the operator of the vehicle. Increased incidents and congestion leads to more turbulent traffic conditions which increases fuel usage and emissions.

### 3.6.5 Junction Impacts

As well as the merging and weaving issues associated with the frequency of junctions on the N40, previous sections have identified that congestion issues currently exist at junctions on the N40 and that these can have a significant effect on the ability of the N40 to efficiently carry the required traffic demand. As such, it is important to identify the causes of this congestion.

The existing location and layout of the N40 junctions are set out in Figure 1.1. The junctions which experience congestion / delays and which impact on the operation of the N40 are outlined in Tables 3.7 and 3.8 below.

Period	Location	Potential Reason for Issues
AM	Mahon Interchange	Intermittent queuing through Mahon Interchange onto N40 due to inadequate capacity at adjacent Mahon Point signalized junction
	Kinsale Road Interchange	Queuing back from traffic lights at roundabout onto auxiliary lane
PM	Mahon Interchange	Intermittent queuing through Mahon Interchange onto N40 due to inadequate capacity at adjacent Mahon Point signalized junction
	Bloomfield Interchange	Intermittent queuing on the auxiliary lane due to capacity constraints at the roundabout on the R610 Rochestown Road

**Table 3.7 – N40 Westbound Issues**

Period	Location	Potential Reason for Issues
AM	Dunkettle Interchange	Consistent queuing back from traffic lights at roundabout through Jack Lynch Tunnel to Mahon Interchange and frequently beyond
	Mahon Interchange	Queuing through Mahon Interchange onto auxiliary lane due to inadequate capacity at adjacent Mahon Point signalized junction
	Togher Interchange	Intermittent queuing back from yield line at the top of diverge onto N40 due to inadequate capacity at this junction and also the adjacent roundabout on the Pouladuff Road / Tramore Road
PM	Dunkettle Interchange	Consistent queuing back from traffic lights at roundabout through Jack Lynch Tunnel
	Mahon Interchange	Queuing through Mahon Interchange onto auxiliary lane due to inadequate capacity at adjacent Mahon Point signalized junction
	Bloomfield Interchange	Intermittent queuing on the off ramp due to capacity constraints at the roundabout on the R610 Rochestown Road
	Douglas East Diverge	Queuing back onto auxiliary lane due to capacity constraints at the signalized junction on the R610 Douglas Road at the bottom of the diverge
	Douglas West Diverge	Queuing back onto auxiliary lane due to capacity constraints at the roundabout junction on the R851 South Douglas Road at the bottom of the diverge
	Togher Interchange	Intermittent queuing back from yield line at the top of diverge onto N40 due to inadequate capacity at this junction and also the adjacent roundabout on the Pouladuff Road / Tramore Road

**Table 3.8 – N40 Eastbound Issues**

In addition to the above, the Kinsale Road Eastbound Diverge experiences some queuing during the peaks but as yet the queues do not encroach on the N40. In the future, as demand increases, these queues may extend back to the N40 and cause issues for mainline traffic.

It is envisaged the majority of the issues set out above will worsen as traffic flows increase in the future.



### 3.7 Conclusions

In summary, the assessment of existing conditions has found that the N40 frequently experiences traffic congestion and travel time unreliability due to a combination of high mainline flows and frequent, congested junctions.

On the basis of the discussion set out above, the requirements of demand management measures are as follows:

- Address the strong levels of growth in transport demand, predominantly through managing growth in the level of discretionary traffic, such that the strategic function of the N40 can be protected;
- Manage and mitigate the safety and reliability impacts that result from congested conditions, and which also threaten the strategic function of the N40

In essence, these requirements relate to the need to influence demand that may be attracted to the N40, and subsequently manage the traffic that nevertheless has chosen to use the N40. This suggests two very different forms of management, one based on influencing the generation of demand and the other based on controlling traffic flow which materialises, a distinction that has been recognised throughout the study.

---

## 4.0 Assessment of Demand Management

### 4.1 The Problem

The Identification of Need is one of the key requirements for the preparation of Business Cases, as referenced in the DTTAS Guidelines<sup>7</sup>. In essence, the need describes the problem that is to be addressed by the project. In this instance, as set out in Section 1, future traffic demand on the N40 will need to be managed if the N40 and the Jack Lynch Tunnel are not to act as a constraint on development within the Cork Metropolitan Area.

Transport Infrastructure Ireland is, inter alia, charged with the management of the national road network, in such manner that the primary functions of the road network can be protected. It is widely accepted that national roads are an important driver of economic growth and competitiveness, supporting balanced regional development, and ensuring access to jobs, businesses and education, as well as securing connections between communities and markets.

Roadspace, for the most part, operates by demand being met on a first-come first-served basis. There are limited current interventions on national roads which allocate roadspace to those who need it most, apart perhaps from the Dublin Port Tunnel where capacity is specifically reserved for freight movement.

The subsequent behaviour of users leads to significant external impacts, where additional trips on the network lead to congestion, journey time reliability and environmental impacts imposed on other users. This leads to significant inefficiencies in the demand for roadspace, particularly under congested conditions, where lower-value discretionary traffic can impact on the journey time of higher-value traffic (including business and freight) which is of greater importance to the national economy.

The analysis of existing conditions presented in Section 3 demonstrates significant congestion on the N40 at peak times arising from significant demand and also from the frequency of junctions along the route. This is forecast to get worse as traffic demand increases.

This increasing demand is likely to lead to a number of consequential problems, which comprise:

- An erosion of the strategic function of the N40 as the hub of the National Road system in the South West Region;
- Consequential restraint on the transportation of goods and services and hence economic activity, primarily within the South West Region, but also further afield;
- The increased risk of collisions that results from high-speed traffic flow in congested or near-congested conditions, and the subsequent risk of knock-on incidents that may result from traffic disruption; and
- Degradation in air quality and noise impacts as traffic flows increase to the point of congestion.

The objective of demand management is therefore to address such inefficiencies by ensuring a more optimised allocation of road capacity such that the maximum level of benefit can be derived from the provision of such roads.

The indicative scheme of specific demand management measures that has been developed achieves this.

---

<sup>7</sup> Guidelines on a Common Appraisal Framework for Transport Projects and Programmes: DTTAS: June 2009: Section 9.1.7.

---

## 4.2 Stakeholder Consultation

Consultation with relevant stakeholders in the region was a key element of the study, both to provide information on the work undertaken and the measures that were emerging from the studies, and also to canvass their views as to the role of demand management on the N40 and the specific objectives that demand management on the N40 should achieve. Contact was made with the following groups or organisations and formal or informal consultations were held with most of them:

- Cork City Council,
- Cork County Council,
- South West Regional Authority,
- National Transport Authority,
- Cork Chamber of Commerce,
- CASP Steering Committee,
- CASP Transport Sub Committee,
- An Garda Síochána,
- Bus Éireann,
- Port of Cork,
- Cork Airport Authority,
- Ringaskiddy Employers Group
- Emergency Services
- Motorway Maintenance and Renewal Contractor

Furthermore, the study scope was discussed with the Department of Transport, Tourism and Sport.

A consultation plan for formal consultation was prepared and implemented based on three specific strands:

- Consultation Strand 1 – Group Consultation:  
This strand was facilitated by the CASP Transportation Sub Committee which contains representatives from the majority of the key stakeholders.
- Consultation Strand 2 – Individual Consultations:  
Individual consultation meetings were held with consultees at appropriate stages in the study programme. These stages were:
  - at study initiation;
  - when baseline conditions were identified and;
  - when the emerging demand management strategy had been identified.
- Consultation Strand 3 – Ad hoc Consultations:  
Meetings were held as required with stakeholders or stakeholder organisations to brief them on particular aspects of the study. Examples of these include meetings with both the Cork City Council Transport SPC and the Cork County Council Transport SPC.

### 4.3 Specific Objectives of the Demand Management Measures

The objectives are the main frameworks that guided the development and assessment of alternative demand management solutions. Throughout the study, measures were benchmarked and evaluated against these Objectives, which were structured around the five criteria referenced in the Common Appraisal Framework. These are:

#### **Economic Objectives:**

To improve the efficiency of the N40 through the active allocation and management of demand for road space to those users who maximise benefit and minimise adverse impact with a view to the N40 being managed to support economic growth;

To highlight the impact of potential redirection of traffic from the N40 to other parts of the wider road network arising from demand management measures and to examine options for minimising same;

To maximise the value of the N40 by improving journey time reliability using effective management solutions;

To reduce the economic impact of delay that results from incidents on the N40 through improved and better integrated management.

#### **Integration Objectives:**

To align with policy objectives on a National, Regional and Local level including Smarter Travel;

To facilitate better understanding of the requirements for integrated land use and transport planning policies in developing areas adjoining or adjacent to the N40 and to contribute to the better understanding of an integrated approach to the transport system in Cork.

#### **Environmental Objectives:**

To contribute to the reduction in CO<sub>2</sub> emissions, air pollution and noise arising directly from traffic congestion on the N40.

#### **Safety Objectives:**

To reduce the frequency and severity of collisions on the N40;

To reduce knock-on safety risks that result from incidents on the N40 as a result of associated shockwaves, congestion and unmanaged diversions to alternative routes.

#### **Accessibility and Social Inclusion Objectives:**

To facilitate the use of Public Transport along the N40 and on the radial routes that cross the N40;

To maintain and improve opportunities for access to business, employment, education, health and recreation where appropriate via the N40.

These objectives formed the basis for the comparison of alternatives.

## 5.0 Potential Demand Management Solutions

### 5.1 Definition and Analysis of Alternatives

#### 5.1.1 Structure of Sifting

The demand management study for the N40 examined the opportunities for using a wide range of measures, including Intelligent Transport Technology and Fiscal Measures to manage traffic flow and demand.

As part of the NRA Traffic Management Study<sup>8</sup>, a review of international experience in development and implementation of traffic and demand management strategies was undertaken. The case study review categorised the available implementation options into six categories, as follows;

- Smarter Travel measures;
- Intelligent Transport Systems (ITS) or Traffic Control Measures;
- Traffic Control Centres;
- Fiscal Measures;
- Other Measures; and
- Combined Initiatives.

#### 5.1.2 Sifting of Potential Measures

The case studies along with the assessment of current conditions on the N40, allowed high level conclusions to be drawn regarding the benefits that different strategies and technologies could bring. When compared against the objectives described in Section 4 it was possible to undertake a sifting exercise to define those measures which should be brought forward for further consideration. The sifting exercise, along with a short summary of key considerations, is presented below in Table 5.1.

Category	Measure	Initial Assessment	Possible ✓
			Reject ✗
Smarter Travel	Travel Planning and Awareness	Measures to be considered which can support in managing N40 demand.	✓
	Planning Policies	Development adjacent to national roads is covered under the DoE Spatial Planning Guidelines <sup>9</sup>	✓
	Integrated Land Use and Transport	Closer integration of land use and transport policies in the Cork Metropolitan Area to be considered in managing N40 demand.	✓
	<i>Support travel planning at local level, supported by relevant planning policies at national level. Integration of land use and transport planning in the Cork Metropolitan Area to be supported.</i>		

<sup>8</sup> National Roads Traffic Management Study: National Roads Authority, February 2011

<sup>9</sup> <http://www.environ.ie/en/DevelopmentHousing/PlanningDevelopment/NationalSpatialStrategy/>

ITS / Control	Upgrade to Motorway	Upgrade of N40 to Motorway Status will remove L-Drivers, pedestrians, cyclists and slow vehicles and will have safety and capacity benefits	✓
	Access Control	Only feasible at a very limited number of individual sites. Impact severe off the N40.	✓
	Incident Detection	Can lead to strong benefits. Existing Dublin Traffic Control Centre could be extended to cover N40.	✓
	Variable Speed Limits	Good safety benefits at higher flows	✓
	<i>It is proposed that Upgrade to Motorway, Incident Detection and Variable Speed Limits form part of the management of the N40 in the short to medium term. Access control is only feasible at a very limited number of locations, and will be examined as such.</i>		
Capacity	Reversible Lanes	No real potential on N40 due to requirement for additional width.	✗
	Hard Shoulder Running	No real potential on N40 due to requirement for additional width and restrictions on the Douglas Flyovers and frequency of junctions.	✗
	Interchange Capacities	Using the existing roadspace to provide additional queuing capacity at a number of interchanges may be feasible. This is to be examined further. Significant upgrade to interchanges is outside the scope of this study.	✓
	Junction Capacities	There are a number of interchanges on the N40 affected by the lack of capacity at adjacent non-national road junctions. Addressing these issues would help prevent traffic queuing back onto the N40.	✓
	Alternative Complementary Routes	Potential to provide short lengths of alternative complementary route which give improved east – west connectivity along the southern fringe of Cork City as an alternative to the N40	✓
<i>There are no practical means of increasing capacity along the N40 through reversible lanes or hard-shoulder running. There is potential to increase queuing capacity at certain junctions (Mahon and Kinsale Road) by using existing hard shoulders. There is also potential to help reduce queue lengths at interchanges by addressing capacity limitations at adjacent non-national road junctions. Provision of improved east-west connectivity along the southern fringe of Cork City would give an alternative to the N40.</i>			

Priority	High Occupancy Lanes	No real potential on N40 due to requirement for additional width. Providing one dedicated lane on a 2 lane dual carriageway would exacerbate congestion.	✘
	High Occupancy Toll Lanes	No real potential on N40 due to requirement for additional width. Providing one dedicated lane on a 2 lane dual carriageway would exacerbate congestion.	✘
	Public Transport Lanes	No real potential on N40 due to requirement for additional width. Providing one dedicated lane on a 2 lane dual carriageway would exacerbate congestion.	✘
	Freight lanes	No real potential on N40 due to requirement for additional width. Providing one dedicated lane on a 2 lane dual carriageway would exacerbate congestion.	✘
	Public Transport Freight Lanes	No real potential on N40 due to requirement for additional width. Providing one dedicated lane on a 2 lane dual carriageway would exacerbate congestion.	✘
	Public Transport Freight Toll Lanes	No real potential on N40 due to requirement for additional width. Providing one dedicated lane on a 2 lane dual carriageway would exacerbate congestion.	✘
	<p><i>The concept of Public Transport Freight (PTF) Lanes has been suggested as the most appropriate means of delivering priority through reallocation of the fast lane. However, given that much of the N40 consists of only 2 through lanes in each direction (with the third lane only linking junctions), dedication of 50% of the road capacity for public transport and freight has been shown to make congestion significantly worse.</i></p>		
Information	Internet	Low cost measure with good benefits	✓
	Telephony	Limited use and high costs warrant unsuitable, unless this can be provided as added-value to an existing facility.	✘
	Roadside Information	Adopt to supplement other systems only	✓
	In-Car Systems	Will become available soon, although these are not considered specific to the N40	✘
	<p><i>Other than roadside information, measures will be delivered regionally or nationally, and are not specific to the N40</i></p>		
Control	National Control Centre	To be progressed arising from the M50 Demand Management Study. N40 could be included in the national control centre.	✓

	Regional Control Centre	Limited potential	✘
	Network Patrols	Existing arrangements could be extended	✔
<p><i>National Control Centre will initially locate in the Dublin Port Tunnel, and control of N40 could represent a further phase of the rollout of the centre. Enhanced network patrols as part of the existing Motorway Maintenance and Renewal Contract arrangements could be provided.</i></p>			
Fiscal	Single Point Tolls	Single point toll in the Tunnel does little to support objectives – leads to diversion through the City Centre with limited impact elsewhere on N40.	✘
	Distance Based Tolling	Strongly supports objectives and to be examined.	✔
	Cordon Charging	Does not support objectives – leads to high diversion and resulting traffic impact associated with local trips.	✘
	Toll by Time	Variable toll supports scheme objectives, although it is recognised that this can be difficult to implement.	✔
	Toll by Congestion	Would be difficult to achieve and is therefore not taken forward.	✘
	Toll by Vehicle Type	Maintain mechanism on existing toll roads, but examine reduction in level of HGV tolls	✔
	<p><i>Analysis of tolling options and resulting impacts suggests that the objectives of the study can be best met through the development of a distance based system which varies by time and charges a lower individual toll at each point. This achieves the objectives of a distance based system, but is akin to the existing free-flow system on the M50 thus limiting technical risk.</i></p>		

**Table 5.1 - Sifting of Potential Demand Management Measures**

The measures brought forward for further investigation and analysis are summarised in Table 5.2.



Category	Measures Taken Forward
<b>Smarter Travel</b>	<ul style="list-style-type: none"> <li>• Travel Planning &amp; Awareness</li> <li>• Planning Policies</li> <li>• Integrated Land Use and Transport</li> </ul>
<b>ITS / Control</b>	<ul style="list-style-type: none"> <li>• Upgrade to Motorway</li> <li>• Access Control</li> <li>• Incident Detection</li> <li>• Variable Speed Limits</li> </ul>
<b>Capacity</b>	<ul style="list-style-type: none"> <li>• Interchange Capacities</li> <li>• Junction Capacities</li> <li>• Alternative Complementary Routes</li> </ul>
<b>Priority</b>	None
<b>Information</b>	<ul style="list-style-type: none"> <li>• Internet</li> <li>• Roadside Information</li> </ul>
<b>Control</b>	<ul style="list-style-type: none"> <li>• National Control Centre</li> <li>• Network Patrols</li> </ul>
<b>Fiscal</b>	<ul style="list-style-type: none"> <li>• Distance Based Tolling</li> <li>• Toll by Time</li> <li>• Toll by Vehicle Type</li> </ul>

**Table 5.2 - Summary of Measures to be Considered Further**

The resulting measures scheduled above are discussed in greater detail in the sections below.

Each section describes the feasibility work and other analysis that has been undertaken in respect of each, concluding on its ability to support the required objectives.

## 5.2 Analysis Tools

### 5.2.1 Overview

In order to undertake a robust assessment and appraisal of the potential measures a detailed traffic model was developed specifically for the project.

The N40 Traffic Model is a local area model encompassing the N40 and the wider network within Cork City and Metropolitan Area and was developed based on the 2008 CASP Traffic Model as updated for use on the design of the Dunkettle Interchange. The model was further updated with traffic data as set out in Section 3.3.1.

Future year traffic forecasts were subsequently developed based on the methodology set out in 5.3 Traffic Forecasting of the TII Project Appraisal Guidelines. That guidance sets out separate methodologies for establishing trip end growth for internal and external zones within a local area model (LAM).

To enable the development of growth factors for the zones contained within the CASP Traffic Model, a relationship was established between CASP zones and the zones contained within TII's National Traffic Model (NTM). The NTM is made up of 874 zones, each of which contains demographic data (population, employment and car ownership) for a base year of 2010 and forecast years of 2025 & 2040.

Demographic data is available for three future year growth scenarios namely TII Low, Medium and High. The future year traffic forecasts for the NTM are based on demographic and economic projections which have been prepared at a zonal level. The medium growth projections are consistent with aggregate forecasts prepared by the Central Statistics Office scenario M0F1 which assumes zero net-migration. High and Low projections represent upper and lower bounds on anticipated growth over the same period. The NTM uses a Trip Attraction Generation Model (TAGM) to convert these demographic and economic indicators into trip ends for each NTM zone.

Therefore future year growth in traffic for the N40 Traffic model is based on the forecast growth in population and employment within the study area.

### 5.2.2 Future Demand Forecasts

The Cork Area Strategic Plan (CASP), which was updated in 2008, sets out various targets for population and employment growth in the metropolitan Cork area. It is acknowledged that the target date for the achievement of this growth in CASP of 2020 is no longer realistic, in light of the economic downturn and net outward migration that has occurred in the period since 2008. However, for the purposes of this study, it was considered that the population and employment growth targets in CASP remain valid targets to be achieved at some date in the future and that these targets should be used to form the basis of the future N40 demand. Accordingly, an assessment was undertaken to identify which NTM future year growth scenario best matched the population and employment growth targets in CASP and Tables 5.3 and 5.4 below summarise the findings of this assessment.

Location	CASP	National Transport Model Population Forecasts					
	2020	Low 2030	Medium 2030	High 2030	Low 2050	Medium 2050	High 2050
Cork City	<b>150,000</b>	125,360	127,040	129,380	129,752	134,865	<b>141,431</b>
Metropolitan Area	<b>216,240</b>	189,714	193,475	198,195	197,476	206,598	<b>218,468</b>
Remainder of CASP Area	<b>121,760</b>	<b>135,577</b>	139,214	143,838	143,579	152,999	165,641
<b>Total</b>	<b>488,000</b>	450,651	459,729	471,413	470,806	<b>494,462</b>	525,540

**Table 5.3 – Comparison between CASP and NTM Population Forecasts**

Location	CASP	National Transport Model Employment Forecasts					
	2020	Low 2030	Medium 2030	High 2030	Low 2050	Medium 2050	High 2050
<b>Cork City</b>	<b>90,691</b>	80,195	84,914	85,905	75,749	84,752	<b>90,045</b>
<b>Metropolitan Area</b>	<b>82,053</b>	71,990	76,226	77,115	67,002	74,965	<b>79,648</b>
<b>Remainder of CASP Area</b>	<b>43,186</b>	41,036	<b>43,450</b>	43,957	38,336	<b>42,892</b>	45,571
<b>Total</b>	<b>215,930</b>	193,220	204,590	206,977	181,088	202,610	<b>215,264</b>

**Table 5.4 – Comparison between CASP and NTM Employment Forecasts**

The figures highlighted in red in Tables 5.3 and 5.4 above are the NTM forecasts which best match the equivalent figures for CASP 2020. As can be seen, the NTM forecasts for Cork City and the Metropolitan area (those areas likely to have the greatest impact on the N40) which best equate to the CASP 2020 growth are the figures for NTM High Growth 2050. Accordingly, it was considered appropriate to use the High Growth 2050 figures for the purposes of assessing the effects of the proposed demand management measures.

## 5.3 Smarter Travel

### 5.3.1 Travel Planning and Awareness

The current studies have investigated the potential for Area - Based travel planning in order to manage demand on the N40. It is concluded that travel planning can have relatively significant local impacts in terms of reduced traffic demand, or flattening of the peak period profile. This can lead to reductions of up to 20% in local traffic generation during peak periods.

Whilst the impact of such strategies are widespread, and are not confined to an individual corridor such as the N40, it is nevertheless noted that through a regional focus on area-wide travel planning at key sites, significant gains should be achievable. A number of locations have been proposed in this regard:

- Little Island;
- Mahon;
- Douglas;
- Wilton, and;
- Ballincollig.

Travel planning at various levels, be it area based or individual workplaces, still forms one of the most effective soft measures in mobility management. Average reduction in car use as a result of workplace travel plans is 15%, with reductions of up to 30% for school travel plans and 15% for personalised travel plans.

### 5.3.2 Planning Policies

The Spatial Planning Guidelines<sup>10</sup> published in January 2012 brought a number of principles to the fore in terms of the planning for development along national roads corridors. These guidelines support the principles of demand management and will support achieving the objectives of the current studies.

### 5.3.3 Integrated Land Use & Transport

As part of the study, a number of integrated land use and transport measures were considered and the impact of these on the N40 assessed. Measures considered include:

- Expansion of the existing bus routes to provide improved linkages between areas of predominantly residential development and areas of predominantly employment use.<sup>11</sup>
- Provision of the BRT as proposed in the CATS Study<sup>12</sup>.
- Location of future residential and employment development in close proximity to each other and enhanced development within Cork City as opposed to suburban locations.
- Provision of parking charges in suburban shopping and employment centres.

All of the above provided benefits to the operation of the N40 by reducing future traffic growth rates on the road network, thus extending the benefits that accrue from other demand management measures. It is strongly recommended that the existing CASP structures be used to commence the development of an Integrated Land Use and Transport Strategy for the Cork Metropolitan Area as a matter of priority.

## 5.4 Intelligent Transport Systems/Traffic Control

### 5.4.1 Upgrade of N40 to Motorway Status

Currently, the N40, while a national primary road with dual carriageway and grade separated junctions, is not a motorway. The consequence of this, from a traffic perspective, is that pedestrians, cyclists, learner drivers and slow moving vehicles are not currently excluded from the N40. This has two significant effects:

Firstly, there is a safety issue with permitting pedestrians and cyclists access to a high speed and heavily trafficked road. While it is acknowledged that pedestrian and cyclist numbers using the N40 are low, it is a fact that, of the three fatal collisions on the N40 between 2005 and 2013<sup>13</sup>, two of the fatalities were pedestrians. Upgrading the N40 to motorway status would mean that pedestrians and cyclists are legally prohibited from using the road, thus improving safety.

Secondly, the presence of slow moving vehicles during times of high traffic flows along the N40 can have a disproportionately significant impact on traffic flows. The reason for this is that the presence of a slow moving vehicle effectively removes most of the traffic from one lane of the road over a short distance as drivers attempt to overtake. This causes a restriction on traffic flow and consequent congestion. Upgrading the N40 to motorway status would legally prohibit slow moving vehicles from using the road.

---

<sup>10</sup> Spatial Planning and National Roads, Guidelines for Local Authorities: Dept of the Environment, Community and Local Government: Jan 2012

<sup>11</sup> It should be noted that this assessment considered the effect of these linkages on car usage only. No consideration was given as to the commercial viability of the linkages.

<sup>12</sup> This was a high level assessment and did not consider the detailed impacts of reduced roadspace in the city centre due to the provision of BRT facilities.

<sup>13</sup> Ref Road Safety Authority website.

#### 5.4.2 Access Control / Ramp Metering

Ramp metering may be defined as the installation of traffic signals on a grade separated junction on-ramp in order to regulate the flow of traffic joining a motorway or dual carriageway. The purpose of ramp metering is to prevent or delay the onset of traffic flow breakdown on the main carriageway, maximising throughput whilst attempting to minimise disruption to the local road network. This measure is usually implemented to improve congested conditions during peak traffic flow periods.

There are a number of aspects that need to be considered as part of any assessment of the feasibility of implementing ramp metering at a particular site. These are the traffic conditions, the geometric layout and existing safety conditions.

In order for ramp metering to be effective, a road must experience significant delay which can directly or indirectly be attributable to traffic merging at an on slip. It is necessary to consider traffic conditions relating to three separate elements of the road network prior to assessing site suitability. These are mainline traffic flow, the on-slip traffic flow and traffic flow on the adjacent local road network.

It has been found through experience that sites which have the following characteristics can benefit greatly from ramp metering if the site is well designed and the correct metering strategy can be applied:

- Short or sub-standard merge areas;
- Where a bottleneck exists downstream on the main carriageway such as a bend or a gradient;
- Two lane on-slips which have been artificially reduced to one lane in an attempt to restrict joining traffic;
- Sufficient distance between the stop line on the merge and the main carriageway for vehicles to accelerate to the desired operational speed; and,
- Ability to store a sufficient number of vehicles such that, when queuing occurs, impact to movements on the adjacent local traffic network is minimised.

The assessment of sites has concluded that the number of junctions suitable for Ramp Metering on the N40 is limited. This is mainly due to the provision of Lane Gains on the most heavily trafficked section of the N40 between Togher and Dunkettle and the lack of storage capacity to minimise impacts on the local road network.

Furthermore, on the most heavily trafficked sections of the N40, much (though not all) of the existing disruption is associated with diverging activity and queuing on exit ramps. Ramp Metering will not address this problem.

The only area identified where ramp metering would provide benefits for the N40 is the westbound on-slip at Bloomfield Interchange. This location contains a number of features identified in the above bullet points including sub-standard merge areas, a downstream bottleneck (Douglas Flyovers), two lane on slips reduced to one lane and sufficient distance between the potential stop line and the main carriageway. The traffic modelling has demonstrated that there is insufficient ability to store vehicles and has demonstrated that impacts on the local road network, including the N28 national primary route, are significant. Detailed design work on optimising the operation of the Bloomfield Interchange and its interaction with the N40 is being undertaken as part of the M28 Cork Ringaskiddy Upgrade Scheme and further detailed examination of potential ramp metering will be undertaken.

In summary the work concluded that ramp metering would either not provide benefits to the N40 or may not be feasible due to the impacts on roads off the N40. Some further work is being undertaken in relation to this in respect of the Bloomfield westbound on-slip<sup>14</sup>.

### 5.4.3 Incident Detection

The studies have included the provision of Incident Detection as a key strategy for managing demand along the N40. The MIDAS Incident Detection system is proposed on the basis that infrastructure for this system has already been installed on the M50 and, in order to facilitate the monitoring of the system in the Traffic Control Centre, it is appropriate that the N40 systems be compatible with the M50. Specific requirements comprise the provision of an appropriate incident management desk within the Traffic Control Centre, and the establishment of lines of communication between the incident room, key media outlets and the emergency services all of which will be provided as part of the M50 demand management processes and can be expanded for use with the N40.

The detection and management of incidents will reduce the safety risks associated with knock-on incidents following a collision or breakdown, and provide ample warning to other road users of potential disruption such that this can be taken into account in trip planning. Guidance developed by the Highways Agency<sup>15</sup> outlines that at a lane flow greater than 15,000 AADT, the case for Incident Detection is strong. This guidance is set on the basis of standard unit rates for the provision of MIDAS infrastructure on existing roads.

The study concluded that there is a strong case for the delivery of Incident Detection on the N40 using this method, supported by the Traffic Control Centre.

### 5.4.4 Variable Speed Limits

The study has examined the practicality and effectiveness of Variable Speed Limits (VSL) along the N40. Good guidance exists on the implementation of VSL, as does good information on its impacts and benefits.

In order for a VSL to be adopted as an efficient means of reducing overall travel time on any network, a number of conditions should exist, such as a drop in capacity at the end of a congested area, the ability to limit the flow of traffic into the congested area, lane gains at merges and a sufficient length of motorway to control the flow of traffic into the congested area.

Based on the conditions outlined above, the entire N40 is suited to the implementation of VSL (once the Dunkettle Interchange has been upgraded), and VSL would be expected to have a notable impact on journey time reliability and safety as the N40 experiences periods of near-congestion.

## 5.5 Capacity Enhancement

### 5.5.1 Hard Shoulder Running

A feasibility study of the provision of Hard Shoulder Running on the N40 has demonstrated that the current cross section is not compatible with the use of the hard shoulder as a running lane. The current design standard for the width of the hard-shoulder is 2.5m, with 3.5m running lanes.

There is no potential for reorganising the cross section to provide for Hard Shoulder Running without widening of the carriageway, or a reduction in the width of running lanes. In addition, hard shoulders do not currently exist on the Douglas Flyovers.

---

<sup>14</sup> At the time of publication of this report, ramp metering was not proposed at this location. However, the issue of ramp metering will be reviewed when further more detailed design is progressed in the area.

<sup>15</sup> TD45/94: Motorway Incident Detection and Signalling: Highways Agency: December 1994

Furthermore, with the N40 supporting auxiliary lanes, the provision of Hard Shoulder Running would be challenging to continue through junctions. As such, they would increase the capacity of the auxiliary lanes and may not therefore lend any significant benefit to the operation of the N40.

### 5.5.2 Interchange Capacities

The feasibility studies have demonstrated that while hard shoulder running is not feasible, it may be feasible to use the hard shoulders at a number of junction off ramps to increase the queuing capacity and thus prevent traffic queues extending back onto the N40 and impacting on N40 traffic flows.

This intervention has been shown to provide benefits on both off ramps at the Mahon Interchange and at the westbound off ramp at the Kinsale Road Interchange.

### 5.5.3 Junction Capacities

The traffic modelling carried out on the N40, supported by observations on the ground, has identified that some of the issues for traffic wishing to leave the N40 are caused by capacity constraints, not at the N40 interchange itself, but at adjacent local road junctions. This is particularly the case at the following locations:

- Capacity issues at the Mahon Point signalised cross roads causes traffic to queue back and interfere with the operation of the Mahon Interchange on the N40.
- Capacity issues at the Rochestown Road Roundabout at the bottom of the N28 diverge causes queuing traffic to interfere with westbound traffic leaving the N40 at the Bloomfield Interchange.
- Capacity issues at the roundabout on the South Douglas Road causes traffic to queue back on the Douglas East off ramp onto the N40.
- Capacity issues at the roundabout between the Pouladuff Road and the Tramore Road adjacent to the Togher off-slips caused primarily by the amount of u-turning traffic causes traffic to queue back down the slip road and on to the N40.

High level assessments have been carried out at all of these locations and, in all cases, relatively minor improvements to the junctions have been shown to have a potentially significant beneficial effect on the operation of the N40. However, due to the complexities of traffic movements in the areas, it is recommended that detailed traffic assessments be carried out to confirm the findings of the high level assessments.

### 5.5.4 Alternative Complimentary Routes

One of the challenges faced by the N40 is that there are limited alternatives available for traffic wishing to travel from the east of the city to the west or vice versa. The study examined previously identified links which would help to address this deficiency and provide alternative routes to the N40 for traffic. The two options examined were:

- The Airport to Sarsfield Road Link identified in the Cork Airport SLAP<sup>16</sup>.
- The East-West Link Bridge and associated roads in Douglas identified in the Douglas LUTS<sup>17</sup>

<sup>16</sup> Special Local Area Plan for Cork Airport, September 2010, Cork County Council

<sup>17</sup> Douglas Land Use and Transport Strategy, August 2013, MVA in association with Cork County Council

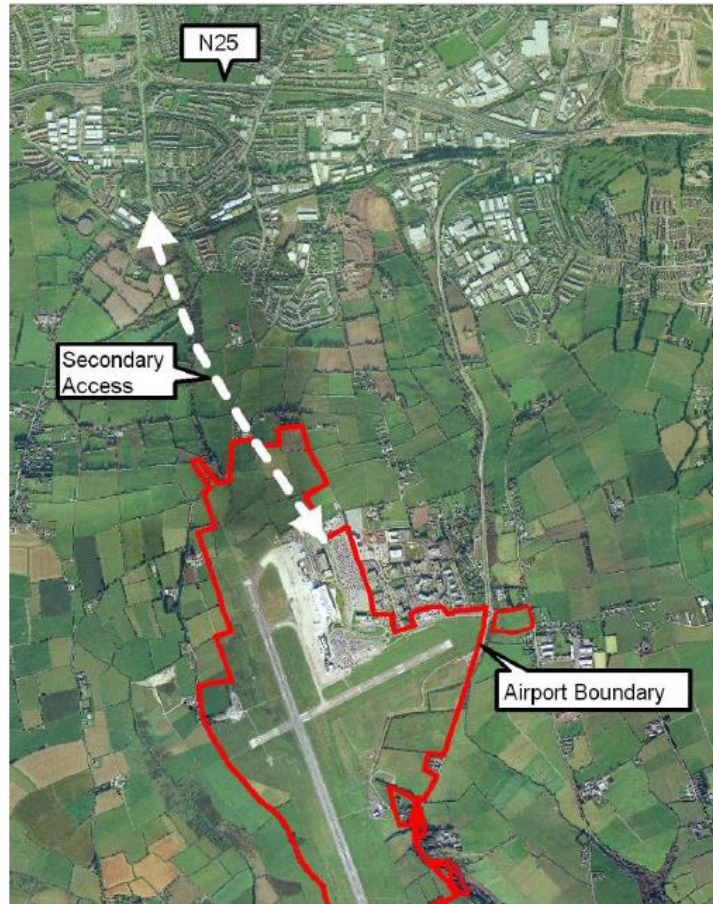

**Figure 5.1 – Airport to Sarsfield Road Link<sup>18</sup>**



**Figure 5.2 – Douglas East-West Link<sup>19</sup>**

<sup>18</sup> Figure 4.2 - Special Local Area Plan for Cork Airport, September 2010, Cork County Council

<sup>19</sup> Mapping courtesy of Google Maps



---

Both of these were identified to provide benefits to the N40 operation by providing an alternative for traffic along heavily trafficked sections of the N40.

## 5.6 Priority Measures

### 5.6.1 High Occupancy Toll Lanes

The provision of High Occupancy Toll Lanes was considered on the basis that their provision would achieve the following outcomes:

- They would increase the occupancy within vehicles as a result of the reduced journey time that is available; and
- They would maximise value of the N40 through facilitating faster journey times for higher value road users (e.g. high value commercial activity)

On further analysis, it was identified that the provision of such lanes would actually increase journey times and congestion on the N40 due to the fact that most sections of the N40 have only two mainline lanes. Restricting traffic in one of these lanes to high occupancy or tolled traffic will dramatically increase traffic demand in the remaining lane leading to increased congestion.

Furthermore, the current studies have concluded that a fiscal solution, such as a distance based multi-point tolling scheme, will be a necessary element of the final scheme of demand management measures if it is to be successful in addressing traffic demand. Where a fiscal proposal is implemented, this is not compatible with a lane-specific tolling solution. As a result, this solution is not taken forward.

### 5.6.2 Public Transport/Freight/Toll Lanes

For similar reasons set out above, it is not considered that a Public Transport/Freight Toll Lane would be compatible with a fiscal solution for the N40, and this is therefore not taken forward.

## 5.7 Information Measures

### 5.7.1 Internet

The provision of Variable Speed Limits, Incident Detection, and supporting Road User Charging schemes will require a high level of deployment of roadside detection and monitoring equipment, which will be collated and monitored through the Traffic Control Centre. The provision of information to road users via the internet – either through posting on web pages, or news feeds, is a low cost means of providing relevant, up to date information on the road network. During times of congestion, this information can be used to actively encourage potential road users to make alternative travel arrangements, and in this context can be an effective demand management tool.

Such a facility is taken forward on the basis of its low marginal cost and high relative impact in comparison to costs.

### 5.7.2 Roadside Information

Roadside information is disseminated through Variable Message Signs, which are not currently provided throughout the Cork Area, but which are intended to be rolled out over the short term.

Roadside information can provide dynamic information that is fully up to date to road user's mid-trip, and therefore has a significant advantage over web feeds in this context. The provision of roadside information is taken forward given its benefits to road users.

---

## 5.8 Network Control

### 5.8.1 National Control Centre

The Intelligent Transport Systems measures set out earlier are all based on the provision of a traffic control centre to monitor road conditions, respond to incidents and provide relevant information to road users. It is envisaged that a single control centre would manage all the operational functions of the national roads network. This control centre will most likely be based around the existing Control Centre in the Dublin Port Tunnel.

For the management of tolling facilities, it is not necessary that this should be accommodated at the same location as the operational control centre, as there is no over-riding requirement for interaction between these two facilities.

### 5.8.2 Network Patrols

The incident management and response function of the Traffic Control Centre will require some means of dealing with live incidents on the N40. The concept of network patrol is a good fit with the scope of the motorway maintenance operator of the N40 who currently performs operations and maintenance on the N40 and already provides incident support to the emergency services.

## 5.9 Fiscal Measures

### 5.9.1 Overview

The positioning of toll points on the road network requires consideration of a number of variables, all of which influence the impact of the tolls on the surrounding road network. These include considerations such as:

- The number of toll points to be provided;
- The charge to be levied at each toll point;
- The differential in charges between classes of user, and payment types;
- The impact on the surrounding network;
- The resulting proportional cost of toll collection; and
- The overall business case and the net financial position.

As part of this study, a total of 15 different tolling scenarios were considered, made up of point tolling (single or multi-point), distance based / cordon capture tolls and tolls on selected N40 junctions. Detailed feasibility studies of the tolling options did not form part of this study.

Point tolling uses physical gantries that apply charges to traffic passing them, and hence relies on the ability to capture high proportions of traffic at a single location.

Single point tolling has worked well in urban areas but normally only at tunnels or bridge crossings where alternative routes are relatively long and the cost of the infrastructure is high. On urban motorways, the use of Single Point tolls is more difficult due to the shorter distances between junctions and the consequential ability of users to divert away from short stretches of road in order to avoid the toll at that point. In order to combat this effect, authorities either:

- Develop a closed system, where the payment is calculated on the basis of a recording at both the entry and exit point (closed system multi-point tolling); or
- Develop an open system, where the toll is collected on the basis of a number of individual low-value payments at specific locations along the journey (open system multi-point tolling).

Both these systems were examined as a means of providing a fiscal solution for the N40. It was concluded that both an open and closed system represent viable options for the N40. Single point tolls on the Jack Lynch Tunnel were examined and were determined not to meet the objectives of the study as the demand management effect is localised at the Mahon Interchange to Dunkettle Interchange section of the N40 with limited effect on the more heavily trafficked sections between Kinsale Road Interchange and Bloomfield Interchange.

Distance Based Tolling can be in the form of multiple gantries on sections of the N40 or in the form of gantries at all entry and exit points (cordon capture toll). The proposal considered in the study initially comprised a six gantry Distance Based Toll scenario. This aligns with the study objectives, however it requires a relatively large number of collection points and would alter the business case in relation to a potential increase in investment although this could be offset by an increase in revenues. A cordon approach would require significantly more toll collection locations than the six gantry approaches, as such was not considered further. Due to the relatively uniform spacing of junctions on the N40, it was identified that varying the toll charges by distance travelled was probably not worth the extra effort in terms of the overall business case. As such, the distance based toll was considered less favourable than the multi point toll scenario.

Consideration was given to tolls on selected N40 junctions targeting key access and egress points on the N40. In order to undertake this for the entire N40 the siting of toll collection points would be required on multiple on-ramps and off-ramps at numerous junctions along the N40. This would require approximately 10 – 20 collection sites. Furthermore, due to the close spacing of junctions on the N40, it was identified that this tolling arrangement had the potential to increase traffic demand at non tolled junctions between the N40 and other routes which may not have the available capacity to accommodate increased traffic flows, thus impacting negatively on the operation of these junctions. For these reasons, the option of providing tolls on selected N40 junctions was judged not to meet the objectives of the study.

#### 5.9.2 Distance-Based Charging using Satellite Positioning Systems

Although satellite based road pricing for all vehicles is based on sound economic theory and is in operation in a number of European countries for HGVs, it has yet to be implemented on anything beyond a user trial for passenger cars. A National Road Pricing Scheme, using global navigation satellite system (GNSS) with every vehicle equipped with a GNSS-enabled on-board unit to enable distance-based road charging, was prepared for the Netherlands in 2010. The system was successfully trialled in Eindhoven but was suspended in 2012. This Dutch experience to date highlights the myriad of challenges in successfully bringing a project of this scale into the delivery phase (not to mention mobilisation and successful operation) and suggests that an Irish national scheme could take several years to plan and implement. It is noted that there remains no international experience in successful implementation of full road user charging of this nature.

The main issue restricting the use of the GNSS systems is risk –the capital cost for the Dutch system was estimated at up to €2.5bn, with an operating cost of up to €1bn per annum. Further work would be required to fully understand the cost of implementing and managing such a system and, while there are reliable figures available from the satellite-based HGV charging schemes, forecasting the costs would nevertheless be challenging. In addition, the management of such a system which only operates in one part of a network would be difficult.

#### 5.9.3 Distance-Based Charging using Open or Closed System Multi-Point Tolling

Initial analysis showed that as few as three or four toll points at key sections of the N40 would capture more than 80% of trips on the N40. A closed system would capture 100% of trips but would essentially require ten

toll points (between each junction from Dunkettle to Poulavone) or the equivalent by means of detection of entries and exits at each junction.

On this basis, an assessment of potential solutions for an Open-System Distance-Based Multi Point Toll on the N40, using a range of toll points, was undertaken to enable an understanding of the costs, benefits and impacts of such a solution. Such a system could be designed to provide the flexibility to allow the system to be developed into a closed system in the future if required.

#### 5.9.4 Analysis of Open Distance Based Multi-Point Tolling Solutions on the N40

The range of distance based multi-point tolling options on the N40 hinges on the number of toll points that can be implemented, which in turn defines the appropriate level of charge at each.

Five scenarios were considered for a distance based multi-point tolling solution on the N40 using one broad approach i.e. provision of consistent toll values at different locations, in order to simplify readability of the system. Details of the scenarios considered are shown in Table 5.5 and Figure 5.3.

Scenario No	Toll Rates (based on Car User Class)	Toll Locations
1	€0.60 at each of 3 Toll Points	<ul style="list-style-type: none"> <li>Between Dunkettle and Mahon Interchanges</li> <li>Between Douglas and Kinsale Road Interchanges</li> <li>Between Kinsale Road and Sarsfield Road Interchanges</li> </ul>
2	€0.60 at each of 3 Toll Points	<ul style="list-style-type: none"> <li>Between Dunkettle and Mahon Interchanges</li> <li>Between Mahon and Bloomfield Interchanges</li> <li>Between Douglas and Kinsale Road Interchanges</li> </ul>
3	€0.90 at each of 2 Toll Points	<ul style="list-style-type: none"> <li>Between Dunkettle and Mahon Interchanges</li> <li>Between Douglas and Kinsale Road Interchanges</li> </ul>
4	€0.45 at each of 4 Toll Points	<ul style="list-style-type: none"> <li>Between Dunkettle and Mahon Interchanges</li> <li>Between Mahon and Bloomfield Interchanges</li> <li>Between Douglas and Kinsale Road Interchanges</li> <li>Between Kinsale Road and Sarsfield Road Interchanges</li> </ul>
5	€1.20 at each of 3 Toll Points	<ul style="list-style-type: none"> <li>Between Dunkettle and Mahon Interchanges</li> <li>Between Douglas and Kinsale Road Interchanges</li> <li>Between Kinsale Road and Sarsfield Road Interchanges</li> </ul>

**Table 5.5 – Multi Point Toll Scenarios**

The toll charges for Scenarios 1 – 4 were chosen to equate to a distance based charge of €0.20 per km between Dunkettle and Sarsfield Road Interchanges. The higher toll charge for Scenario 5 was chosen to ascertain the impact of such a toll on traffic demand on the N40.

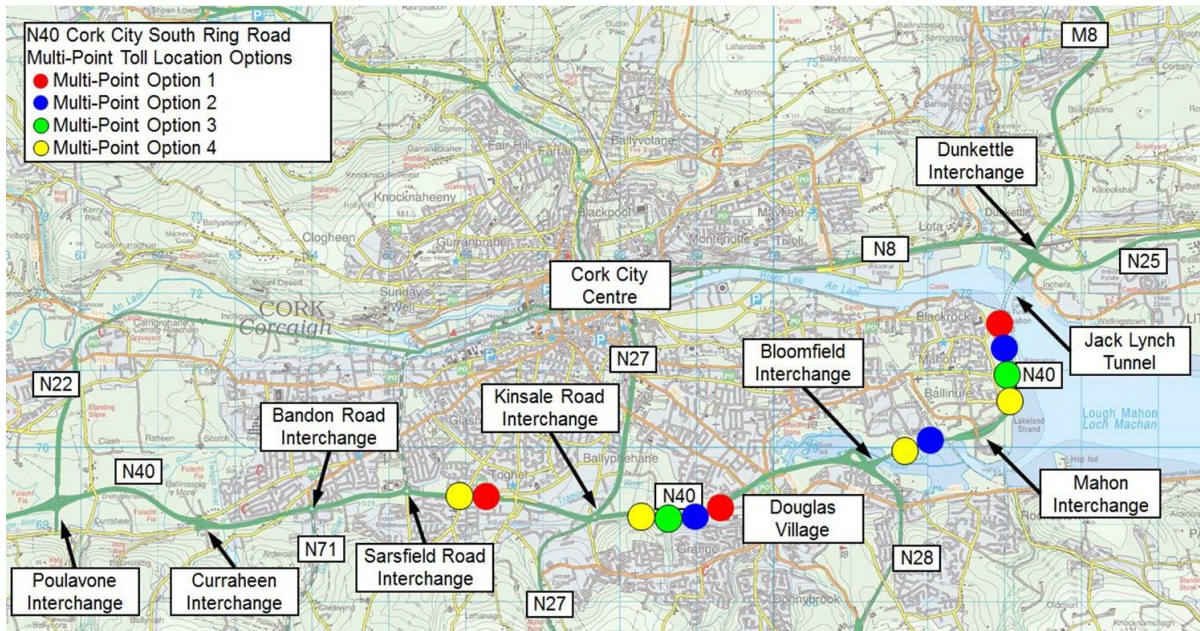

**Figure 5.3 – Multi Point Toll Scenario Locations**

The toll ratios for various vehicle types were based on those currently in use on the national road network as follows:

- Cars 1.0 : 1
- Light Goods Vehicles 1.3 : 1
- 2 / 3 axle Rigid Goods Vehicles 1.8 : 1
- 4 axle Rigid & Articulated Goods Vehicles 2.2 : 1

For the purposes of this study, the toll rates were assumed to be fixed and did not vary:

- by time of day e.g. a lower toll applied during off peak times; or
- dependant on whether users were registered with the toll operator e.g. a higher toll applied to those users who are not registered in order to reflect increased collection costs.

In addition to the above, the toll charges do not include any allowance for possible infrastructure charging to cover ongoing and future investment in the national road network in the Cork Area.<sup>20</sup> Any revenue generated by a future toll scheme could be allocated to the operation and maintenance costs associated with the national roads network, subject to the relevant EU and National regulations.

The scenarios above were input into the N40 Traffic Model and the outputs used as the basis for a comparison of the impacts. The N40 Traffic Model was used as a sifting tool to compare the effects of each toll scenario and identify the scenario which best achieves the objectives identified in Chapter 3. However, as a Fixed Demand Model, the N40 Traffic Model will not identify the full effects of the toll scenarios on trip suppression. The preferred toll scenario was assessed using a Variable Demand Traffic Model and the outcomes of this assessment are included in Section 5.9.6 of this report.

<sup>20</sup> The toll charge can comprise an infrastructure element, an external cost element for externalities and a congestion element. These have to be in line with current EU regulations for HGVs and potential future regulations for passenger cars.

Some key comparisons between the scenarios are as follows:

Traffic Capture (between Sarsfield Road and Dunkettle):

- Scenarios 1 & 5 capture 87% of the traffic with 3 toll points
- Scenario 2 captures 74% of the traffic with 3 toll points
- Scenario 3 captures 71% of the traffic with 2 toll points
- Scenario 4 captures 100% of the traffic with 4 toll points

The impact on total traffic volumes in the forecast year of 2048 at key locations on the road network arising from the various tolling scenarios is shown in Tables 5.6 and 5.7 below as percentage increases or decreases.

Assessment Location	Toll Scenario 1	Toll Scenario 2	Toll Scenario 3	Toll Scenario 4	Toll Scenario 5
N40 Jack Lynch Tunnel	-2%	-3%	-3%	-3%	-5%
N40 Bloomfield - Mahon	-4%	-6%	-5%	-5%	-7%
N40 Kinsale Road - Douglas	-9%	-9%	-12%	-8%	-16%
N27 Michael Collins Bridge	+3%	+6%	+6%	+4%	+8%
N27 South City Link	-5%	-4%	-7%	-3%	-8%
N8 Tivoli Dual Carriageway	+2%	+3%	+3%	+2%	+5%

**Table 5.6 – AM Peak Traffic Volume Changes**

Assessment Location	Toll Scenario 1	Toll Scenario 2	Toll Scenario 3	Toll Scenario 4	Toll Scenario 5
N40 Jack Lynch Tunnel	-1%	-1%	-1%	-1%	-2%
N40 Bloomfield - Mahon	-1%	-3%	-1%	-2%	-2%
N40 Kinsale Road - Douglas	-4%	-3%	-5%	-3%	-9%
N27 Michael Collins Bridge	+1%	+1%	+1%	+1%	+1%
N27 South City Link	-1%	0%	0%	-1%	-1%
N8 Tivoli Dual Carriageway	0%	0%	0%	0%	+1%

**Table 5.7 –PM Peak Traffic Volume Changes**

Analysis of the cost of collecting tolls compared to the toll revenue shows that for Scenarios 3 and 5, the toll revenue significantly exceeds the cost of collection. For Scenarios 1 and 2, the cost of collection and the toll revenue are broadly similar and for Scenario 4, the cost of collection significantly exceeds the toll revenue.

An indicative and comparative analysis of the cumulative journey time along the entire N40 from Poulavone to Dunkettle was undertaken (on the basis of fixed demand only) looking at the most critical situation i.e. eastbound in the 2048 pm peak. This indicative and comparative analysis demonstrated that for Toll Scenarios 1 – 4 inclusive, there were no journey time improvements when compared to the non-toll situation. In some cases the journey time actually deteriorated due to traffic wishing to divert off the N40 causing increased congestion at certain interchanges, particularly the Kinsale Road Interchange. Toll Scenario 5 did show a 1-2 minute reduction in overall journey time due to the reduction in traffic volumes on the N40.

In light of the above data, the following conclusions were drawn:

- Scenario 2 is less preferred as it captures less traffic than Scenarios 1 & 5 for the same number of toll points.
- Scenario 4 is less preferred as the cost of collecting the tolls outweighs the toll revenue gathered.
- Scenario 3 is less preferred as eastbound traffic wishing to avoid paying tolls seeks to divert off the N40 at Kinsale Road Interchange thus causing significant capacity issues at this junction.

Accordingly, a three point toll solution was identified as the optimum for Distance Based Multi-Point Tolling on the N40, with the tolls located in the following sections:

- Dunkettle to Mahon;
- Douglas West to Kinsale Road;
- Togher to Sarsfield Road.

### 5.9.5 Indicative Distance Based Variable Multi-Point Tolling Solution on the N40

The emerging preferred option for a Multi-Point Tolling solution on the N40 is set out in Figure 5.4.

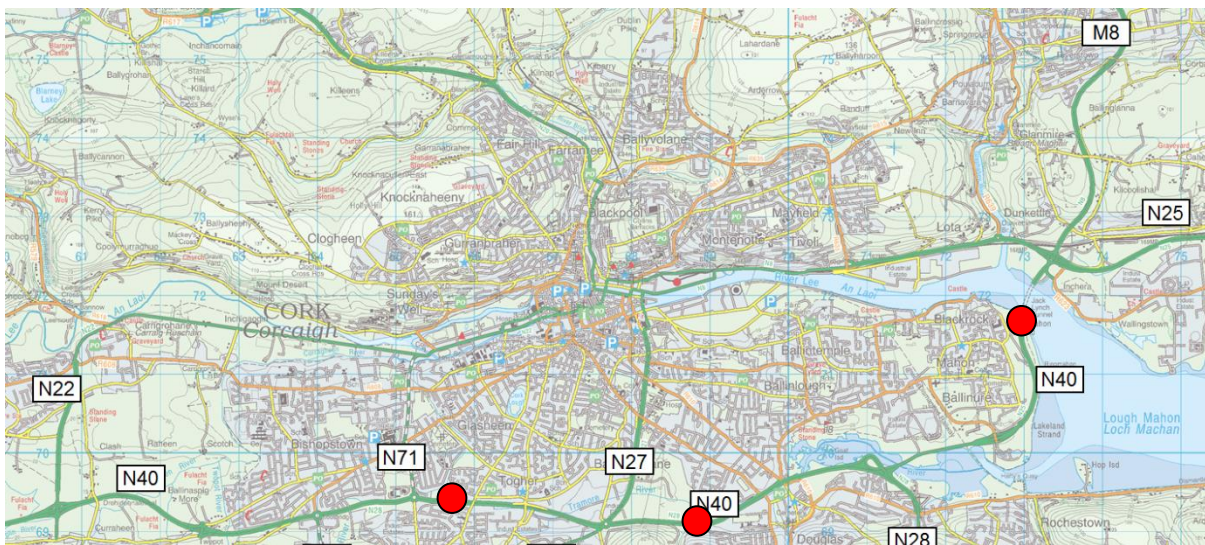

**Figure 5.4 – N40 Distance Based Multi-Point Tolling**

It is acknowledged that the solution presented here will be subject to review at an appropriate time, should there be a decision to proceed with such a scheme for the N40. The level of detail assessed as part of this

study is not sufficient for a detailed Toll Study. Furthermore, the operating cost and accuracy of toll collection equipment and processes are constantly changing. In this regard, it is prudent prior to implementation to undertake a review of the Multi-Point solution, in addition to giving greater consideration to a closed system.

### 5.9.6 Variable Demand

Following identification of the preferred locations for multi-point toll charging points, an assessment was undertaken of the likely variable demand response associated with Toll Scenario 1. The variable demand response takes account of vehicle trips which will not occur due to the presence of the toll and thus is more representative of actual conditions than the fixed demand response. The impact on total traffic volumes in the forecast year of 2048 at key locations on the road network arising from the Toll Scenario 1 with the variable demand response is shown in Table 5.8 below as percentage increases or decreases. By comparing the data in Table 5.8 below with the relevant data in Tables 5.6 and 5.7, the effect of trip suppression arising from the implementation of the toll can be identified.

Assessment Location	AM Peak – Toll Scenario 1 Variable Demand Response	PM Peak – Toll Scenario 1 Variable Demand Response
N40 Jack Lynch Tunnel	-10%	-2%
N40 Bloomfield - Mahon	-14%	0%
N40 Kinsale Road - Douglas	-18%	-7%
N27 Michael Collins Bridge	+6%	-2%
N27 South City Link	0%	-2%
N8 Tivoli Dual Carriageway	+2%	-2%

**Table 5.8 –Effect of Variable Demand**

### 5.9.7 Tolling Technology

For the purposes of this study, it has been assumed that any tolling system on the N40 will use the technology that is currently employed at the M50 eFlow toll point. The following is required as part of the roadside installation:

- Gantries (2 gantries per toll site per direction);
- A vehicle presence detector;
- Cameras with Automatic Number Plate Recognition (ANPR) technology for recording video-registered customers;
- Directional Short Range Communications (DSRC) beacons for reading the On Board Units (OBU or “tag”) of tag-registered customers; and
- Wired communications systems for transfer of data to the back office;



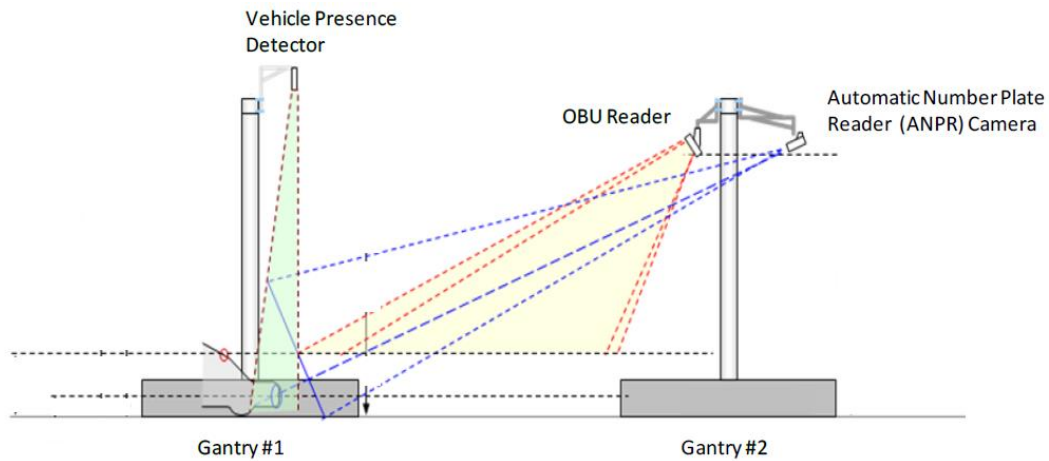

**Figure 5.5 - Road User Charging Installation**

In addition to the standard installation set out above, consideration should be given to include rear-facing ANPR cameras to support the image recognition process. This would further improve the quality of number plate recognition.

In relation to the operation of the toll scheme, it is assumed that the necessary infrastructure and operations could be provided through TII's second generation M50 tolling operations contract which has scope for expansion to other parts of the network, subject to the statutory approvals process.

## 6.0 Summary of Indicative N40 Demand Management Scheme

### 6.1 Identification of Indicative Scheme

The further analysis of the shortlisted measures described above allowed the indicative package of measures to be defined in order to address the demand management objectives set out for the N40. These measures are outlined below in Table 6.1.

N40 Intervention	Description of Specific Measures
<b>Integrated Land Use and Transportation</b>	<ul style="list-style-type: none"> <li>• Travel Planning &amp; Awareness</li> <li>• Land Use Policies</li> <li>• Public Transport</li> <li>• Parking Policy</li> </ul>
<b>Targeted Upgrades</b>	<ul style="list-style-type: none"> <li>• Upgrade to Motorway</li> <li>• Dunkettle Interchange Upgrade</li> <li>• Off Line Junction Improvements</li> <li>• Hard Shoulder Queuing</li> </ul>
<b>Smart Motorway Interventions</b>	<ul style="list-style-type: none"> <li>• Traffic Control Centre</li> <li>• Variable Speed Limits</li> <li>• Variable Messaging Signage</li> <li>• CCTV</li> <li>• Incident Detection</li> <li>• Network Patrols</li> </ul>
<b>Alternative Complimentary Routes</b>	<ul style="list-style-type: none"> <li>• Douglas East-West Link</li> <li>• Airport – Sarsfield Road Link</li> </ul>
<b>Fiscal</b>	<ul style="list-style-type: none"> <li>• Multi Point Tolling</li> </ul>

**Table 6.1 - Summary of the Indicative Scheme of Specific Demand Management Measures**

A schematic layout and architecture of the preferred strategy is presented below as Figure 6.1.

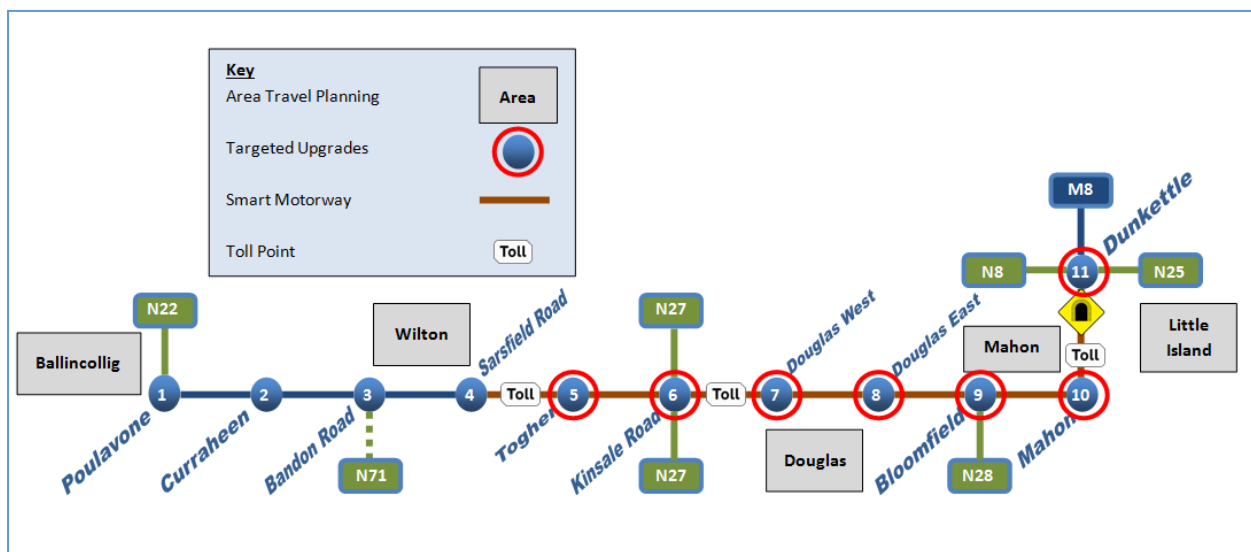

**Figure 6.1 – Proposed Indicative Scheme of Specific N40 Demand Management Measures**

The schematic shows the extent of the Variable Speed Limit and Incident Detection between Dunkettle Interchange and Sarsfield Road Interchange, supported by Variable Message Signs and web information as a means of disseminating information. The National Traffic Control Centre is a key element of this suggested deployment strategy.

The locations of potential toll points are also shown, which would include the e-Flow back office which manages the toll collection system.

Not shown on the schematic, but included in the N40 Demand Management Strategy are the alternative complimentary routes comprising the east-west link in Douglas and the Airport to Sarsfield Road link.

## 6.2 Key Stakeholders

During the study, the Steering Group discussed the study with the Department of Transport, Tourism and Sport (DTTAS), the National Transport Authority (NTA), the Strategic Policy Committee (SPC) of the two Local Authorities, various other transport stakeholders and the Cork Chamber of Commerce<sup>21</sup>. The purpose of the discussions was as follows:

- To provide information on the work undertaken and the measures that were emerging from the studies;
- To ensure that the work was fully compatible with other policies and plans being developed at government level; and
- To identify the legal and institutional framework that would be necessary to implement the measures included in the emerging proposals.

In general, there was a degree of commonality in the questions asked and the views expressed by the various stakeholders. Some key issues raised / comments made were:

- A degree of acceptance that the problem exists and some intervention is required;
- Opposition to the proposed fiscal measures (tolling) by local Cork based stakeholders, with little or no support for tolls along the N40, particularly due to the perceived risk of tolls on the N40 causing increased congestion within Cork City;
- Acceptance for the non-fiscal measures, but residual concern that any intervention on the N40 may detrimentally affect existing congestion in the City Centre and / or affect the viability of existing employment areas.

## 6.3 Benefits and Impacts of the Measures

### 6.3.1 Integrated Land Use & Transportation

As noted in the M50 Demand Management Study Report, evidence of the success of previous examples of Area Based Travel Planning projects around the UK is well documented. The largest proponent for this type of approach has been the Highways Agency in England who, through their 'Influencing Travel Behaviour' programme has aimed to tackle congestion and improve air quality on some of Britain's busiest roads by changing attitudes to travel, increasing available choice of modes and furthering co-operation.

---

<sup>21</sup> The full list of stakeholders consulted is included in Chapter 3 of this report.

In a joint presentation entitled ‘Travel Plans – the Potential is Realised<sup>22</sup>’ the case for this approach was made by the Highways Agency and TRL by presenting results from a number of key sites from around the UK. In particular, results were analysed from Cambridge Science Park on the A14, Solent Business Park in Hampshire off the M27, and Northampton General Hospital off the A45.

The following bullets summarise the main findings:

- Single Occupancy Vehicle trips reduced by 1% in Cambridge, 12% at Solent with Northampton General showing a 10% reduction;
- Increases in Active Travel (walking and cycling) varied from 1.3% at Cambridge, 5% at Solent and 3% in Northampton;
- Car sharing increased by 1.2% in Cambridge, 14.5% at Solent and 3% in Northampton;
- The benefit to cost ratio of the projects at the three sites were 13:1, 3.7:1, and 5.5:1 respectively; and
- Journey times for trips using the strategic road network near each of the sites reduced by between 1% in Northampton and 7.3% at Solent with Cambridge showing a reduction of 5.6%

These results highlight that, even in the case of the example with the most modest levels of success, significant impacts are observed particularly in the increase of car sharing against single occupant car trips, and in journey time reductions. It may also be observed that the benefit to cost ratio for the project with the lowest proportional increase in car-sharing has the highest benefit to cost ratio of the three which could indicate that this was the site with the most significant initial issue, or that this was the scheme with the lowest level of funding available. It is noted that the benefit to cost ratio is highly dependent on the initial level of congestion and is therefore highly sensitive to initial conditions.

The key qualitative successes of these schemes include;

- Launching car sharing websites and incentivising these using travel vouchers and financial rewards;
- Increased cycling and public transport use promoted via travel plan bulletins, posters, websites and other local media outlets;
- Designation of car-sharing bays at workplaces;
- The setting up of new travel related forums for businesses and interested parties at locations around the country to discuss and tackle common travel issues using a co-ordinated approach with shared risks and benefits;
- Increase cycle parking facilities at sites nationally; and
- Improved bus services at many sites brought about by direct contact with public transport operators and improved communication between parties.

It is also noteworthy that the National Transport Authority (NTA) have been very active in the Cork Metropolitan Area in promoting workplace, school and 3<sup>rd</sup> level education travel planning, through their Smarter Travel Programme. The NTA have identified that the following benefits can be achieved from the Smarter Travel Programme<sup>23</sup>:

---

<sup>22</sup> Travel Plans – the Potential is Realised, Evidence from the Highways Agency’s ITB Programme, Highways Agency and TRL

<sup>23</sup> From NTA presentation to the CASP Transportation Sub Committee Meeting 11<sup>th</sup> February 2016

- Workplace travel plans can reduce car use between 10% and 25%
- School travel plans have reduced car use by 10%
- Residential travel plans (7-15% reduction in car usage)
- Public awareness campaigns (3–12% reduction in car usage)
- Car sharing and car clubs (3% reduction in car usage)

Cork County Council and An Bord Pleanála have also been involved in applying planning conditions for mobility management plans for large scale development in the Cork Area. One of these was the redevelopment of the Port of Cork facility in Ringaskiddy where conditions were applied to restrict new traffic on the network during peak traffic times to mitigate the effect of the development on existing traffic congestion.

For the five locations which have been identified as suitable for area-wide Travel Planning (Little Island, Mahon, Douglas, Wilton and Ballincollig) reductions in car usage of up to 7.5% have been identified as being reasonably achievable without significant investment in new public transport infrastructure (e.g. Bus Rapid Transit)<sup>24</sup>. As these benefits are dependent on a range of factors outside of the control of TII, they have not been included in the detailed assessments carried out on the overall Demand Management Strategy. However, notwithstanding this, it must be emphasised that an approach to integrated land use and transportation incorporating area travel planning is a crucial prerequisite in the management of traffic demand on the N40 and without this, the benefits of all of the other interventions will be quickly eroded by the growth in traffic and increasing congestion on the overall road network in the Cork Metropolitan Area.

### 6.3.2 Traffic Control and Management Measures

For the purposes of assessment, the Targeted Upgrades, Smart Motorway Interventions and Alternative Complimentary Routes have been combined as Traffic Control and Management Measures.

The Targeted Upgrades include the following specific offline junction improvements and hard shoulder running provisions to address current congestion issues on the N40:

- Upgrade to the Mahon Point Traffic Light Junction to improve throughput from Mahon Interchange towards Skehard Road.
- Upgrade to the R610 Rochestown Road Roundabout Junction to improve throughput for traffic exiting from the N28.
- Upgrade to the R851 South Douglas Road Roundabout Junction to improve throughput for traffic exiting from the N40.
- Upgrade to the Pouladuff Road Roundabout Junction to improve throughput for traffic exiting from the N40.
- Provision of a hard shoulder queuing lane for N40 eastbound traffic exiting at Mahon Interchange.
- Provision of a hard shoulder queuing lane for N40 westbound traffic exiting at Kinsale Road Interchange.

As traffic patterns change over time and traffic growth occurs, additional targeted junction improvements will be required in the future as follows:

---

<sup>24</sup> Based on the findings published in “Personalised Travel Planning in Midleton, Co Cork” in the proceedings of the ITRN 2011.

- Provision of an additional eastbound approach lane to the Kinsale Road Interchange circulating carriageway.
- Provision of a free flow slip lane at the Poulavone Interchange from the eastbound off ramp to the N22 northbound.

The benefits provided by the Traffic Control and Management measures are outlined in the following sections.

#### 6.3.2.1 N40 Queuing

The introduction of the Targeted Improvements as part of the Scheme provides specific infrastructure improvements to remove queuing from the N40 and to prevent queuing from blocking back onto the N40 mainline. The baseline conditions assessment identified existing capacity constraints that currently lead to queuing blocking back onto the N40 mainline, which impacts significantly on the efficient operation of the N40. In addition to the existing known blocking back issues, the forecast model runs identified potential future capacity constraints where the increase in traffic volumes resulted in junctions reaching capacity and blocking back on the N40.

The benefits provided by the removal of stationary vehicles in static queues from the N40 are two-fold. Firstly, the removal of all of the queuing from adjacent junctions that block back onto the N40 mainline and cause significant delays and congestion, improves the overall operational efficiency of the N40. This allows the N40 mainline carriageway to essentially operate under free-flow conditions, with no impact from stopline capacity issues. Secondly, the queuing will improve the safe operation of the N40 as it reduces the risk of rear-shunt incidents due to the removal of the need for drivers to brake suddenly upon approaching the queue of static vehicles.

#### 6.3.2.2 N40 Journey Times

Table 6.2 details the summary journey time analysis for the N40. The journey times shown represent the worst hourly journey time modelled within the 3 hour peak period for all options, ensuring that a robust worst-case scenario comparison is undertaken. It considers the end-to-end eastbound journey times on the N40 between the Dunkettle Interchange and the Poulavone Interchange for the AM and PM peaks under full CASP development, for the Do Nothing, Do Minimum and N40 Traffic Control and Management scenarios. The Do Nothing is included to provide context in relation to the improvements provided by the Dunkettle Interchange Upgrade which is the only intervention included in the Do Minimum scenario.

Scenario	AM Eastbound Journey Time (mins)	PM Eastbound Journey Time (mins)
<b>Do Nothing</b>	39.8	47.1
<b>Do Minimum</b>	15.7	35.5
<b>Traffic Control and Management</b>	11.9	23.5

**Table 6.2 – N40 Summary Journey Times**

The AM Peak eastbound journey time analysis shows that under the Do Nothing scenario average journey times on the N40 would reach up to 40 minutes, due to congestion from the Dunkettle Interchange. The upgrading of the Dunkettle Interchange to a free-flow interchange significantly reduces the journey times to

less than 16 minutes. The implementation of the N40 Traffic Control and Management Scenario further reduces eastbound average journey times on the N40 to less than 12 minutes.

The PM Peak eastbound has the highest journey times on the N40. The Do Nothing has journey times increasing to 47 minutes, with the Do Minimum reducing these journey times to 35 minutes. While the Do Minimum improves eastbound journey times there are still delays on the N40 eastbound associated with the traffic blocking back from the Kinsale Road Interchange Off-Ramp and also from the Mahon Interchange Off-Ramp, impacting on the operation of the N40 mainline traffic. The implementation of the N40 Traffic Control and Management Scenario shows further significant reductions in journey times to 23 minutes, through the removal of the impacts associated with the blocking back from the Kinsale Road Interchange and from the Mahon Interchange. There are still some delays on the N40 eastbound in the PM peak associated with the On-Ramp merge from the Kinsale Road Interchange, where there is a significant amount of merging and weaving traffic on the N40 resulting in localised delays on the N40 mainline.

### 6.3.2.3 N40 Vehicle Speeds

Based on the above N40 Journey Times and the distance from the Poulavone Interchange to the Dunkettle Interchange the average end-to-end N40 Vehicle Speed was determined for the Do Minimum and the N40 Traffic Control and Management scenarios in the full CASP development scenario for the AM and PM peak hours. These are shown in Table 6.3.

Scenario	AM Eastbound Average Vehicle Speed (kph)	PM Eastbound Average Vehicle Speed (kph)
<b>Do Minimum</b>	57.4	25.3
<b>Traffic Control and Management</b>	75.6	38.3

**Table 6.3 – N40 Average Vehicle Speeds**

Table 6.3 shows that the average vehicle speed increases with the introduction of the N40 Traffic Control and Management when compared to the Do Minimum. Table 6.3 shows that once CASP has been fully developed with the N40 Traffic Control and Management Scenario in place the average speed in the eastbound direction during the peak hour are at 75kph during the AM peak hour and 38kph during the PM peak hour.

### 6.3.2.4 N40 Reliability Benefits

Reliability benefits refer to improvements in journey time reliability. Day-to-day variations in traffic congestion arise from day-to-day variations in demand. As congestion builds, journey times become increasingly unpredictable. These fluctuations in journey time represent additional disutility to drivers, over and above the actual delay experienced. Journey time reliability is significant to many road users as it allows for better planning for the journey and allows the road user to make better use of their time, be it for personal, business or freight trips.

Reliability is measured in terms of Standard Deviation (SD) from the mean journey time. Typically the higher the ratio of flow to capacity (V/C) on a given lane, the greater the Standard Deviation of travel time. Variable Speed Limits can help to stabilise flow and create more uniform lane utilisation between the available lanes. As a consequence of more evenly balanced lane distribution, traffic flow will improve along the most heavily congested sections of the N40.

The assessment shown below in Tables 6.4 and 6.5 compares the standard deviation of the full CASP development Do Nothing, Do Minimum and N40 Traffic Control and Management Scenarios for eastbound traffic on sections between the Dunkettle Interchange and the Sarsfield Road Interchange. Sections further west are not included as there is no variation in standard deviation due to the low traffic volumes on the N40.

N40 Section	Do Nothing Standard Deviation (mins)	Do Minimum Standard Deviation (mins)	N40 Traffic Control & Management Standard Deviation (mins)
Dunkettle – Mahon	41	5	5
Mahon - Bloomfield	5	5	5
Douglas Flyover	5	5	5
Douglas – Kinsale Road	6	5	5
Kinsale Road Flyover	5	5	5
Kinsale Road – Sarsfield Road	5	5	5

**Table 6.4 – N40 Eastbound AM Peak Journey Time Reliability**

N40 Section	Do Nothing Standard Deviation (mins)	Do Minimum Standard Deviation (mins)	N40 Traffic Control & Management Standard Deviation (mins)
Dunkettle – Mahon	54	5	5
Mahon - Bloomfield	10	10	5
Douglas Flyover	13	13	10
Douglas – Kinsale Road	54	54	5
Kinsale Road Flyover	5	5	5
Kinsale Road – Sarsfield Road	45	45	5

**Table 6.5 – N40 Eastbound PM Peak Journey Time Reliability**

Tables 6.4 and 6.5 above show that the introduction of the Dunkettle Interchange in the Do Minimum will provide for reliable northbound journey times through the Jack Lynch Tunnel resulting from the removal of the stopline capacity constraint at the existing Dunkettle Interchange. It can be seen that the introduction of



the N40 Scheme measures further improve the journey times reliability through the removal of the queuing blocking back on the N40 from the adjacent junctions, in particular at Mahon Interchange, Douglas Village, Kinsale Road Interchange and Togher Interchange.

The N40 eastbound at the Douglas Flyover is seen to have a higher standard deviation than any other section even following the introduction of the N40 Scheme; this is to be expected as it has the highest lane demand on the N40. This section shows that the introduction of the N40 Scheme improves the reliability as a result of the introduction of the Variable Speed Limits and the Alternative Complementary Route Provision providing alternative routes to this section of the N40.

The travel time variability that may result from major incidents on the road network is not accounted for in this assessment, and is determined in the following section of this report.

#### *6.3.2.5 Reduction in Incident Delay Benefits*

Any incident, whether a collision or mechanical breakdown of a vehicle, that occurs on a carriageway will give rise to delays for motorists. Whilst the prevalence of incidents arising from a mechanical breakdown will remain unchanged with the proposed measures in place the impact these breakdowns have on congestion will be reduced due to reduced response times and efficient management of flow using VSL.

Mechanical breakdowns cause brief blockages of at least one traffic lane while serious incidents involving personal injuries or fatalities can result in lengthy closures of one or more lanes. The potential impact of incidents was demonstrated during the journey time surveys carried out for this study, with an incident shown to increase the maximum pm eastbound journey time by a factor of nearly 2 compared to the maximum journey times without an incident.

The introduction of the Smart Motorway measures, as part of the N40 Traffic Management and Control Scenario, is identified to have the following benefits to incident rates and incident durations:

- 26% reduction in incidents;
- 2% reduction in one-lane and two-lane incident duration; and
- 5 minute reduction in relation to fire, load shedding and spillage incident duration.

Taking account of the above benefits due to Variable Speed Limits and Incident Detection, the analysis suggests that the proposed measures will lead to a saving of between 16,000 hours and 21,000 hours of traffic delay per annum, increasing as traffic flows increase over time.

#### *6.3.2.6 Broader Cork Metropolitan Network Effects*

This section considers high level modelling statistics associated with the entire Cork Metropolitan Network as modelled in the SATURN Traffic Model. These statistics give an indication as to the overall network operations for the Do Minimum and N40 Traffic Control and Management scenarios. The network statistics considered are:

- Transient queues;
- Over-capacity queues;
- Total travel time;
- Total travel distance; and
- Average speed.

Transient queues are those which build up and dissipate throughout the modelled period (for example at signals each cycle) and over-capacity queues are those which build up throughout the modelled period and carry over into the next period.

Table 6.6 and Table 6.7 detail the network level statistics for the AM and PM peak periods, respectively. It can be seen that the introduction of the N40 Traffic Control and Management Scenario improves the general operation of the Cork Metropolitan network by reducing over-capacity queues (with an associated increase in transient queues), reducing total travel time and increasing the average vehicle speed, in both the AM and PM periods.

Network Criterion	Unit	Do Minimum	N40 Traffic Control & Management
<b>Transient Queues</b>	PCU hours	2,416	+0.72%
<b>Over-Capacity Queues</b>	PCU hours	2,073	-5.6%
<b>Total Travel Time</b>	PCU hours	14,505	-0.8%
<b>Total Travel Distance</b>	PCU km	469,115	+0.28%
<b>Average Speed</b>	kph	32.3	+1.2%

**Table 6.6 – AM Peak Network Statistics**

Network Criterion	Unit	Do Minimum	N40 Traffic Control & Management
<b>Transient Queues</b>	PCU hours	2,839	+1.4%
<b>Over-Capacity Queues</b>	PCU hours	4,253	-6.0%
<b>Total Travel Time</b>	PCU hours	17,471	-1.4%
<b>Total Travel Distance</b>	PCU km	494,550	+0.29%
<b>Average Speed</b>	kph	28.3	+1.8%

**Table 6.7 – PM Peak Network Statistics**

### 6.3.2.7 Information Measures – Variable Message Signs and Travel Information

A network of Variable Message Signs on the N40 and other key national routes in the Cork Metropolitan Area would be used as part of the demand management measures, but would be complimented by broader use of web-based information tools. The concept is that users will be able to develop a knowledge of historic and current network conditions either:

- Pre-trip, through the use of the travel information website;
- Pre-trip through the dissemination of travel bulletins using SMS or Twitter alerts; or
- In-trip, using the Variable Message Signs.

The cost of issuing up to date travel information via web-based channels is extremely low, but will provide the most widespread form of travel information. This can be used to provide adequate notice of events, maintenance or unplanned network disruption such that travel choices can be changed in response. This is a dynamic form of demand management and is a critical part of managing periods of planned or unplanned congestion on the road network.

Variable Message signs are a more capital intensive form of providing live information. Nevertheless, they are a safe means of providing in-trip information to road users, who will have restrictions on their access to web-based information whilst driving.

The result of the measures proposed here will be that road users will have full information on the condition of the N40, and can plan their trip accordingly.

### 6.3.3 Fiscal Measures – Distance Based Multi Point Tolling

#### 6.3.3.1 Introduction

The introduction of tolls leads to a number of changes in travel behaviour:

- Reassignment, where N40 users change their routing to avoid tolls. For such users, the perceived additional cost associated with using longer routes is therefore less than the cost of the toll;
- Mode switching, where N40 users change travel mode due to the increased cost associated with travelling by private car. Such responses include switching to bus or rail for longer trips, or to walking or cycling for shorter trips;
- Demand changes, which describe decisions to travel to alternative (lower cost) destinations, to link trips together in order to reduce overall travel costs, or decisions not to make a trip at all.

In all these cases, it is those N40 users that derive only marginal benefit from their particular trip who change their travel behaviour. In other words, those N40 users who derive value from their trip that is only marginally higher than the cost of the trip. In such cases, a slight increase in travel costs will displace such users from the N40, ensuring that a higher level of road space remains for those who derive higher values from making trips on the N40.

There are two main types of transport models that can be used to assess the impacts of transport schemes. These are as follows:

- Reassignment Models, which use a fixed traffic demand matrix, and assess impacts of reassignment only; and
- Variable Demand Models, which include consideration of demand changes.

A number of reassignment models exist for the Cork Metropolitan and broader CASP areas. As part of their work for the Dunkettle Interchange Upgrade Scheme, TII (then the NRA) collated all of the relevant data into one detailed SATURN model for the Cork Metropolitan Area which represents the urban area in a high degree of detail, allowing local impacts of reassignment to be better understood.

As part of this study, the SATURN model was further refined along the N40 corridor to allow any reassignment impacts to be assessed.

For assessing Variable Demand effects including assessing the impact of toll schemes, the TII National Transport Model (NTpM) was developed. The NTpM contains traffic, rail and bus demand elements with the Variable Demand Model (VDM) as the central tool of the model suite interfacing with the traffic and public transport elements of the NTpM.

The NTpM was completed in 2011, and is employed by TII in strategic planning studies, transport policy impact assessments and appraisal of road tolling schemes.

The NTpM has been used in combination with the Cork Metropolitan Area SATURN Model to allow both the variable demand and traffic impacts to be fully assessed as part of the N40 Demand Management Strategy.

#### 6.3.3.2 Discussion

Based on the analysis carried out into the potential for fiscal based demand management on the N40, using the traffic modelling approach as set out above, a number of clear conclusions can be drawn as follows:

1. Traffic on the N40 in the morning peak is more sensitive to tolling than in the evening peak.
2. Tolling provides a different outcome on different sections of the N40 – for example the effect of tolls on traffic through the Jack Lynch Tunnel is much less than the effect on the section of N40 between Kinsale Road Interchange and South Douglas Road off ramp. This is most likely due to the fact that alternative routes are available in the N40 Demand Management Strategy between Douglas and Kinsale Road, but no such routes are available for crossing the River Lee.
3. The assessment of variable demand in Table 5.8 clearly identifies that there is the potential for tolling on the N40 to suppress a certain percentage of trips on the overall Cork Metropolitan Road network and this may facilitate an increased patronage of public transport and other smarter travel initiatives.
4. Due to the overall congested road network in the Cork Metropolitan Area, the lack of alternative routes to the N40 and the current lack of an alternative public transport offering along the N40, the toll rate required to encourage traffic to divert off the N40 is likely to be higher than on other routes. Careful consideration is required to analyse the overall effects of additional traffic using already crowded junctions to avoid paying tolls.
5. Tolls on the N40 – even at a high rate – do not significantly impact on traffic flows on radial routes into the City Centre or on bridge crossings in Cork City itself.

In conclusion, it can be clearly seen that a toll on the N40 will be required if traffic continues to grow in order to protect the carrying capacity of the route. Due to the complexity of the overall road network in Metropolitan Cork, careful consideration is required as to the appropriate toll rate to be applied.

## 6.4 Implementation and Phasing

The implementation of the measures included throughout this document requires a number of preliminary activities to support the eventual delivery of the demand management activities. Key requirements are outlined below:

### 6.4.1 Integrated Land Use and Transportation

As noted above, the Cork Local Authorities, in conjunction with the National Transport Authority (NTA), have already commenced the implementation of certain measures under this heading. It is crucial that this existing work be built upon, using the existing CASP structures, to develop an overall strategy for the Cork Metropolitan

---

Area, incorporating all of the transportation and land use stakeholders. It is noted that the current work by the NTA into a Cork Transport Strategy and by Cork City and County Councils into the National Planning Framework may be used to form the basis of this strategy.

## 6.4.2 Traffic Control and Management

### 6.4.2.1 Targeted Upgrades

It may be possible for the Minister for Transport Tourism and Sport to declare the N40 as a motorway using the powers available to him under Section 8 of the Roads Act 2007. This will require further detailed examination – particularly in relation to the standards used for the design of the various interchanges and the provision of alternatives to existing access points off the N40. In the event that a declaration is not possible, a full Motorway Order application will be necessary to An Bord Pleanála in accordance with Section 47 of the Roads Act 1993 (as amended).

The Dunkettle Interchange Upgrade Scheme has already received approval from An Bord Pleanála and has been identified for delivery by 2021 in the Irish Government’s ‘Building on Recovery: Infrastructure and Capital Investment 2016-2021’ plan.

Certain offline junction improvements will be delivered as part of schemes currently in planning or development as follows:

- Upgrade to the R610 Rochestown Road Roundabout Junction to improve throughput for traffic exiting from the N28 will be provided as part of the M28 Cork Ringaskiddy Motorway Scheme.
- Upgrade to the R851 South Douglas Road Roundabout Junction to improve throughput for traffic exiting from the N40 will be provided as part of the roll out of the Douglas Land Use and Transportation Study recommendations.

The remaining offline junction improvements and the provision of the hard shoulder queuing will require their own planning process prior to delivery. In some cases, e.g. Mahon, this may need to be done as part of an overall transport plan for the area.

### 6.4.2.2 Smart Motorway Interventions

Much of the ground work for the roll out of smart motorway interventions on the N40 is currently being done, or has already been done, as part of the development of similar measures for the M50. Significant investment will, however, be required into the physical infrastructure on the N40 to support these interventions. For example, Figure 6.2 below provides an indication of the number of gantries required to support the provision of variable speed limits on the N40. These will be in addition to the provision of incident detection loops on the road surface and cameras for CCTV.

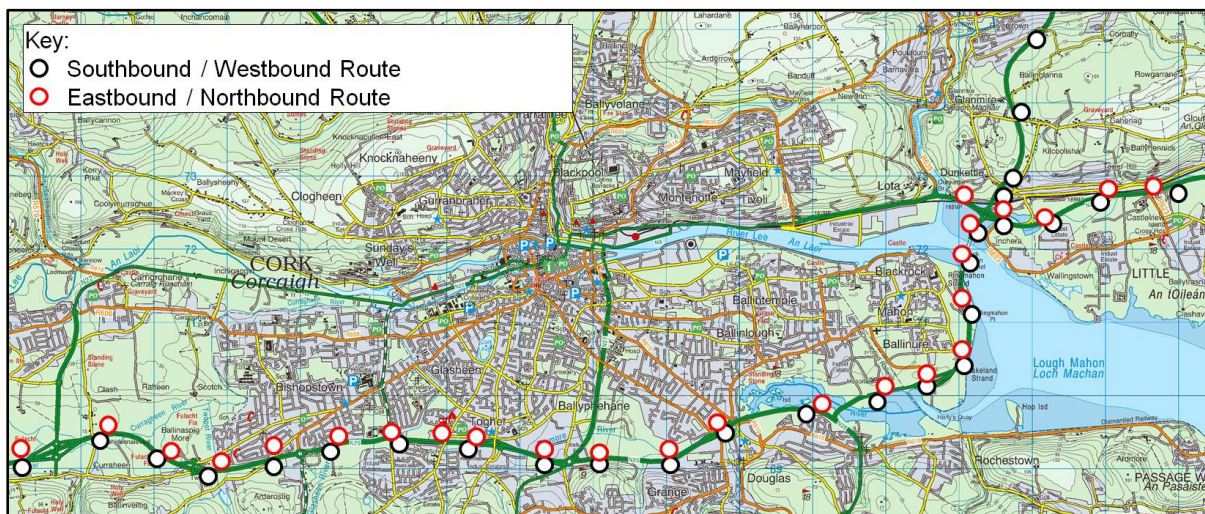

**Figure 6.2 – Gantry Locations along the N40**

#### 6.4.2.3 Alternative Complimentary Routes

As part of the implementation of the Douglas Land Use and Transportation Study recommendations, Cork County Council are expected to commence work in the near future on the planning and design work for the East-West Link bridge in Douglas. Delivery of this scheme will be dependent on funding and is likely to be some time away.

Currently, no work is planned for the development of the Airport to Sarsfield Road Link. This will be kept under review with Cork County Council, particularly in light of ongoing investment in Cork Airport and the associated Business Parks.

#### 6.4.3 Fiscal Measures – Distance Based Multi Point Tolling

The implementation of tolling will require the preparation and approval of a Draft Toll Scheme. The toll scheme would draw on the information prepared as part of this study, and would require a period of at least three years from commencement for consultation (including an approval process from the necessary bodies, namely, the Minister for Transport, Tourism and Sport and the European Commission) and implementation.

The scheme would be also subject to the statutory process set out in the Roads Act which requires approval by the TII Board. The scheme would also consider the mitigation of impacts that would necessarily arise on local roads as a result of the tolling proposals.

The necessary infrastructure and operations could be provided through TII’s second generation M50 tolling operations contract which has scope for expansion to other parts of the network, subject to the statutory approvals process.

### 6.5 Risk Analysis

A summary of risks to the delivery of the strategy is outlined in Table 6.8. The monitoring of risks throughout the implementation stage is necessary to understand the impact on the overall project. This should, and will, form part of the project delivery stage.

Risk	Details	Likelihood	Action
<b>Political</b>	That an Integrated Land Use and Transportation Strategy would not be acceptable to the Elected Members of Cork City or County Council	Low	Work with all stakeholders to emphasise the importance for the future development of Cork in having a properly functioning ring road.
<b>Political</b>	That a decision to implement tolling may not be forthcoming	Moderate	Carry out, in due course, a detailed toll study to identify the impacts of any toll on the surrounding road network and any mitigation that can be provided.
<b>Legislative</b>	That approval to the upgrade of the N40 to motorway status may not be achievable	Moderate	Prepare a detailed assessment of the N40 including all interchanges to identify existing design standards and accesses. Provide mitigation strategy for any impacts arising from the re-designation of the N40.
<b>Legislative</b>	That planning approval to some of the Targeted Upgrades may not be achieved.	Moderate	Work with all stakeholders to emphasise the importance for the future development of Cork in having a properly functioning ring road. Consider alternatives to the specified upgrades.
<b>Affordability</b>	That the significant investment required to implement the Smart Motorway Interventions will not be available	Low	The importance of the N40 has already been acknowledged by TII. Consider the development of an implementation and phasing strategy such that the Smart Motorway Interventions can be delivered over a longer timescale, thus spreading the cost.

<b>Economic</b>	That strong economic growth will continue leading to very high levels of traffic growth on the N40	Moderate	Accelerate the development of the Integrated Land Use and Transportation strategy such that traffic growth is encouraged away from the N40 at peak times. Move forward with the detailed toll study for the N40.
<b>Technology</b>	That the technology required for the N40 Smart Motorway Interventions may not be available at reasonable cost.	Low	Build on the work currently underway on the M50 and reuse wherever possible the technologies developed for the M50.

**Table 6.8 - Risk Register: Phase 1 (Feasibility)**



## 7.0 Conclusions

This study has been undertaken by Transport Infrastructure Ireland in light of the condition imposed by An Bord Pleanála on the Dunkettle Interchange Upgrade Scheme as set out below.

***The applicant shall provide for and adhere to the following requirements in the proposed road development:***

***(a) Following commissioning of the proposed road development, the National Roads Authority shall, at intervals not exceeding twenty four months, review and upgrade the regional traffic model. At each review the road authority shall, in addition to measurement of traffic flows and validation of the model, include specific inputs for extant grants of planning permission within the Cork Metropolitan area. It shall publish this traffic flow information on the website of the National Roads Authority, and***

***(b) Within six months of the date of the Board Order an automatic traffic counter shall be provided on a permanent basis on the N40 National Primary Road in close proximity to the Jack Lynch Tunnel to provide on-going recording and monitoring of traffic flows.***

***Reason: To provide for on-going monitoring and review of traffic flows on the road network at the interchange, in order to indicate capacity to facilitate traffic generated by additional development, having particular regard to the capacity constraints of the Jack Lynch Tunnel.*** (Emphasis added)

In light of the above and the fact that traffic studies for the Dunkettle Interchange Upgrade Scheme identified that under certain traffic growth scenarios, the threshold of 90% of the tunnel capacity (as identified by the An Bord Pleanála assisting inspector) could be reached within the next decade, it was recognised that future traffic demand on the N40 would need to be managed if the N40 and the Jack Lynch Tunnel were not to act as a constraint on development within the Cork Metropolitan Area.

The study has identified that, in the peak periods, congestion is regularly occurring on the busiest sections of the N40. The study has also shown that demand for use of the N40 will continue to rise in the coming years, with congestion, delays and incidents all increasing significantly if this demand is not actively managed.

In response Transport Infrastructure Ireland investigated a wide range of possible alternatives and developed an indicative scheme of specific demand management measures for the N40, covering the N40 between Junction 4 (Sarsfield Road) and Junction 11 (Dunkettle). The various elements of the indicative scheme are set out in Table 7.1 overleaf;

N40 Intervention	Description of Specific Measures
<b>Integrated Land Use and Transportation</b>	<ul style="list-style-type: none"> <li>• Travel Planning &amp; Awareness</li> <li>• Land Use Policies</li> <li>• Public Transport</li> <li>• Parking Policy</li> </ul>
<b>Targeted Upgrades</b>	<ul style="list-style-type: none"> <li>• Upgrade to Motorway</li> <li>• Dunkettle Interchange Upgrade</li> <li>• Off Line Junction Improvements</li> <li>• Hard Shoulder Queuing</li> </ul>
<b>Smart Motorway Interventions</b>	<ul style="list-style-type: none"> <li>• Traffic Control Centre</li> <li>• Variable Speed Limits</li> <li>• Variable Messaging Signage</li> <li>• CCTV</li> <li>• Incident Detection</li> <li>• Network Patrols</li> </ul>
<b>Alternative Complimentary Routes</b>	<ul style="list-style-type: none"> <li>• Douglas East-West Link</li> <li>• Airport – Sarsfield Road Link</li> </ul>
<b>Fiscal</b>	<ul style="list-style-type: none"> <li>• Multi Point Tolling</li> </ul>

**Table 7.1 - Summary of the Indicative Scheme of Specific Demand Management Measures**

The study highlighted the need for an integrated land use and transportation strategy for the Cork Metropolitan Area with a focus on reducing the significant car commuter demand on the N40 during peak times and the use of the N40 as an access route to the various commercial and retail developments in close proximity to the route. This must be the primary, albeit indirect, demand management measure.

The study demonstrated that there are a number of traffic management and improvement interventions required to the N40 prior to any direct demand management intervention in order to address current capacity constraints, particularly at the junctions. The development of some alternative complimentary routes, as identified in relevant Cork County Council policies, will also benefit the N40 by providing alternative options for N40 traffic.

The assessment of the fiscal demand management measures has been based on an indicative three toll point open system, which provides a coverage rate of greater than 80% of trips. This has been derived to demonstrate the benefits and impacts of such a solution.

The study showed clearly that fiscal measures can have a significant impact on managing future demand on the N40, notwithstanding the complexity of the overall road network in the Cork Metropolitan Area and the limited alternatives to the Jack Lynch Tunnel.

This study demonstrates the feasibility of the indicative demand management measures which can provide a basis for the development of a detailed scheme for implementation.



 Ionad Ghnó Gheata na Páirce,  
Stráid Gheata na Páirce  
Baile Átha Cliath 8, Éire

 Parkgate Business Centre,  
Parkgate Street,  
Dublin 8, Ireland

 [www.tii.ie](http://www.tii.ie)

 [info@tii.ie](mailto:info@tii.ie)

 +353 (01) 646 3600

 +353 (01) 646 3601